

TEST REPORT EN 50438: 2013 Requirements for micro-generating plants to be connected in parallel with public low-voltage distribution networks	
Report reference No.	180807100GZU-003
Tested by (printed name and signature)	Jason Fu Senior Project Engineer <i>Jason Fu</i>
Approved by (printed name and signature)	Tommy Zhong Assistant Technical Manager <i>Tommy</i>
Date of issue	17 Jan., 2019
Contents	51 Pages
Testing Laboratory Name	Intertek Testing Services Shenzhen Ltd. Guangzhou Branch
Address	Block E, No.7-2 Guang Dong Software Science Park, Caipin Road, Guangzhou Science City, GETDD, Guangzhou, China
Testing location	Same as above
Address	Same as above
Applicant's Name	Shenzhen SOFAR SOLAR Co., Ltd.
Address	401, Building 4, AnTongDa Industrial Park, District 68, XingDong Community, XinAn Street, BaoAn District, Shenzhen, China
Test specification	
Standard.....	EN 50438: 2013
Test procedure	Type approval for Greece
Non-standard test method	N/A
Test Report Form No.	EN50438b
TRF originator	Intertek
Master TRF	dated 2014-01
Test item description	Solar Grid-tied Inverter
Trademark	
Manufacturer	Same as applicant
Factory	Dongguan SOFAR SOLAR Co., Ltd 1F-6F, Building E, No.1 JinQi Road, Bihu Industrial Park, Wulian Village, Fenggang Town, Dongguan City
Model and/or type reference	SOFAR 20000TL-G2, SOFAR 25000TL-G2, SOFAR 30000TL-G2, SOFAR 33000TL-G2

Rating.....:	Model	SOFAR 20000TL-G2	SOFAR 25000TL-G2	SOFAR 30000TL-G2	SOFAR 33000TL-G2
	Max. DC input Voltage	1100Vdc			
	Operating MPPT voltage range	230Vdc – 960Vdc			
	Max. Input current	24A/24A	28A/28A	30A/30A	30A/30A
	PV Isc	30A*2	35A*2	37.5A*2	37.5A*2
	Nominal AC output voltage	3/N/PE 230Vac/400Vac			
	Nominal AC output Frequency	50Hz			
	Nominal AC output Power	20000W	25000W	30000W	33000W
	Max. Output Power	22000VA	27500VA	33000VA	36300VA
	Power factor	0.8 Leading – 0.8 Lagging			
	Safety level	Class I			
	Ingress Protection	IP 65			
	Operation Ambient Temperature	-25°C - 60°C			
	Software version	V1.40			

Test case verdicts	
Test case does not apply to the test object ..:	N/A
Test item does meet the requirement	P(ass)
Test item does not meet the requirement:	F(ail)
Testing	
Date of receipt of test item	07 Aug., 2018
Date(s) of performance of test	07 Aug 2018 to 10 Jan 2019
General remarks	
<p>The test results presented in this report relate only to the object tested. This report shall not be reproduced, except in full, without the written approval of the Issuing testing laboratory. "(See Enclosure #)" refers to additional information appended to the report. "(See appended table)" refers to a table appended to the report.</p> <p>Throughout this report a point is used as the decimal separator.</p> <p>When determining the test conclusion, the Measurement Uncertainty of test has been considered.</p> <p>This report is for the exclusive use of Intertek's Client and is provided pursuant to the agreement between Intertek and its Client. Intertek's responsibility and liability are limited to the terms and conditions of the agreement. Intertek assumes no liability to any party, other than to the Client in accordance with the agreement, for any loss, expense or damage occasioned by the use of this report. Only the Client is authorized to permit copying or distribution of this report and then only in its entirety. Any use of the Intertek name or one of its marks for the sale or advertisement of the tested material, product or service must first be approved in writing by Intertek. The observations and test results in this report are relevant only to the sample tested. This report by itself does not imply that the material, product, or service is or has ever been under an Intertek certification program. The test report only allows to be revised only within the report defined retention period unless standard or regulation was withdrawn or invalid.</p>	

General product information:

The Solar converter is a three-phase type.

The unit is providing EMC filtering at the output toward mains. The unit does not provide galvanic separation from input to output (transformerless). The output is switched off redundant by the high power switching bridge and two relays. This assures that the opening of the output circuit will also operate in case of one error.

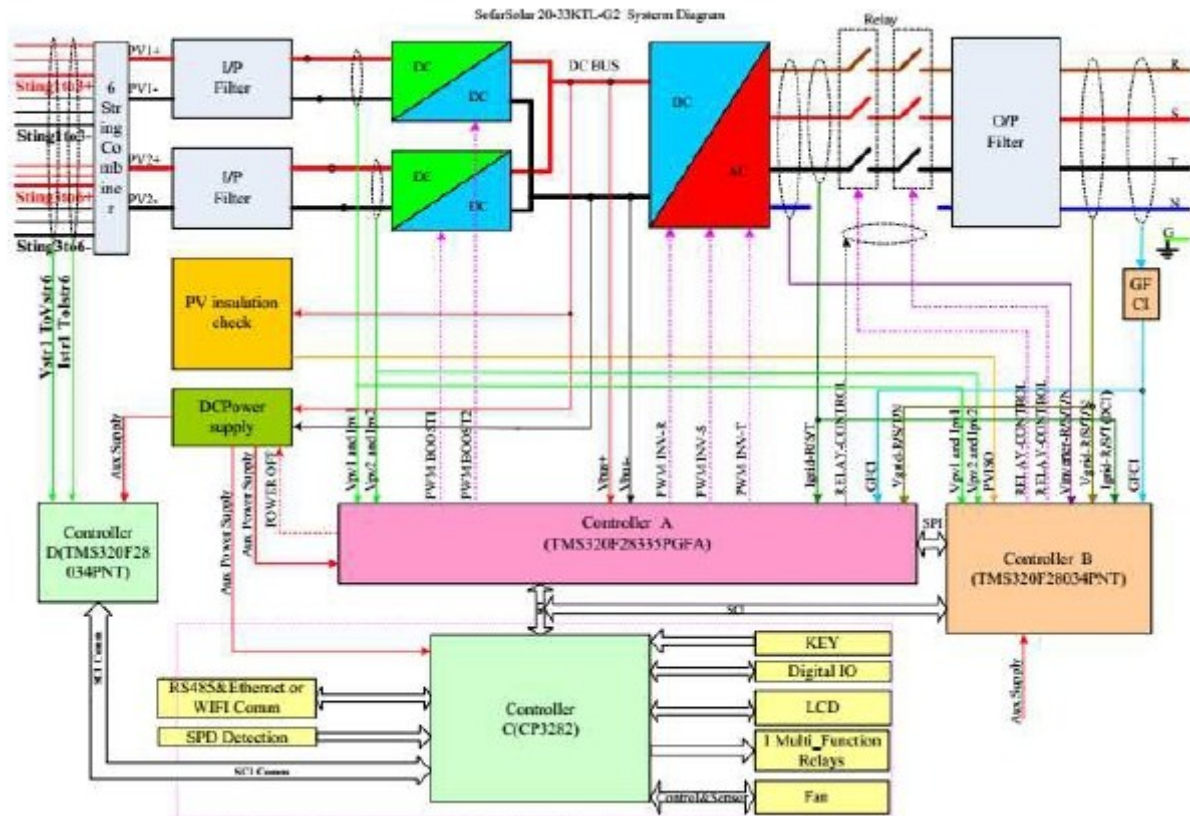

Block diagram

The internal control is redundant built. It consists of Main DSP(UC20) and slave DSP(UC73). The Main DSP(UC20) can control the relays, measures voltage, and frequency, AC current with injected DC, insulation resistance and residual current, In addition it tests the array insulation resistance and the RCMU circuit before each start up. The slave DSP(UC73) is using for detect residual current, also can open the relays independently and communicate with Main DSP(UC20). The unit provides two relays in series on Line conductors. When single-fault applied to one relay, alarm an error code in display panel, another redundant relay provides basic insulation maintained between the PV array and the mains. All the relays are tested before start up. Both controllers(Main DSP(UC20), Slave DSP(UC73) can open the relays

The product was tested on:

Hardware version: V1.00
Software version: V1.40

Model difference:

The models SOFAR 2000TL-G2, SOFAR 2500TL-G2, SOFAR 3000TL-G2 and SOFAR 3300TL-G2 are almost identical in hardware except the shown in the following table and the output power derated by software.

The difference in hardware			
Item	SOFAR 20000TL-G2	SOFAR 25000TL-G2	SOFAR 30000TL-G2 / SOFAR 33000TL-G2
Number of PV terminal	2+2	3+3	
Number of BUS capacitance	8 capacitors: 550V/110μF 2 capacitors: 1100V/40μF		10 capacitors: 550V/110μF 4 capacitors: 1100V/40μF
INV inductance	785μH	735μH	
Combiner board	Not the board	Have the board	
External fan	Not the board	2	3
Relay of output board	6pcs T9VV1K15-12S		3pcs AZSR250-2AE-12D

Other than special notice, the model SOFAR 33000TL-G2 used as representative model for testing.

Factory information:

Dongguan SOFAR SOLAR Co., Ltd.

1F-6F, Building E, No.1 JinQi Road, Bihu Industrial Park, Wulian Village, Fenggang Town, Dongguan City.

Default interface protection as below:

Parameter	Time s	Setting
Over-voltage – stage 1 ^a	3	230 V + 10 %
Over-voltage – stage 2	0.5	230 V + 15 %
Under-voltage	0.5	230 V - 20 %
Over-frequency	0.5	51Hz (islands); 50.5Hz (continent)
Under-frequency	0.5	47.5Hz (islands); 49.5Hz (continent)
LoM	5	Refer to VDE 0126

Tolerances on Voltage: $\pm 1\%U_n$
Tolerances on Frequency: $\pm 0.02\text{Hz}$

Copy of marking plate:

SOFAR SOLAR Solar Grid-tied Inverter

Model No. **SOFAR 20000TL-G2**

Max.DC input Voltage	1100V
Operating MPPT voltage range	230V ~ 960V
Max. Input current	24A/24A
Max. PV Isc	30A/30A
Nominal Grid Voltage	3/N/PE, 400Vac
Max. Output Current	3x32A
Nominal Grid Frequency	50Hz/60Hz
Nominal Output power	20000W
Max. Output power	22000VA
Power factor	>0.99(adjustable+/-0.8)
Ingress protection	IP65
Operating Temperature Range	-25--+60°C
Protective Class	Class I

Manufacturer:Shenzhen SOFARSOLAR Co., Ltd.
Address:5/F,Building 4,Antongda Industrial park,NO.1 Luxian Avenue,Xin'an Street,Bao'an District,Shenzhen City,Guangdong Province,P.R.China

SAA XXXXXX
VDE0126-1-1,VDE-AR-N4105,G59/3,IEC61727,
IEC62116,C10/11,RD1699,UTE C15-712-1,AS4777

SOFAR SOLAR Solar Grid-tied Inverter

Model No. **SOFAR 25000TL-G2**

Max.DC input Voltage	1100V
Operating MPPT voltage range	230V ~ 960V
Max. Input current	28A/28A
Max. PV Isc	35A/35A
Nominal Grid Voltage	3/N/PE, 400Vac
Max. Output Current	3x40A
Nominal Grid Frequency	50Hz/60Hz
Nominal Output power	25000W
Max. Output power	27500VA
Power factor	>0.99(adjustable+/-0.8)
Ingress protection	IP65
Operating Temperature Range	-25--+60°C
Protective Class	Class I

Manufacturer:Shenzhen SOFARSOLAR Co., Ltd.
Address:5/F,Building 4,Antongda Industrial park,NO.1 Luxian Avenue,Xin'an Street,Bao'an District,Shenzhen City,Guangdong Province,P.R.China

SAA XXXXXX
VDE0126-1-1,VDE-AR-N4105,G59/3,IEC61727,
IEC62116,C10/11,RD1699,UTE C15-712-1,AS4777

SOFAR SOLAR Solar Grid-tied Inverter

Model No. **SOFAR 30000TL-G2**

Max.DC input Voltage	1100V
Operating MPPT voltage range	230V ~ 960V
Max. Input current	30A/30A
Max. PV Isc	37.5A/37.5A
Nominal Grid Voltage	3/N/PE, 400Vac
Max. Output Current	3x48A
Nominal Grid Frequency	50Hz/60Hz
Nominal Output power	30000W
Max. Output power	33000VA
Power factor	>0.99(adjustable+/-0.8)
Ingress protection	IP65
Operating Temperature Range	-25--+60°C
Protective Class	Class I

Manufacturer:Shenzhen SOFARSOLAR Co., Ltd.
Address:5/F,Building 4,Antongda Industrial park,NO.1 Luxian Avenue,Xin'an Street,Bao'an District,Shenzhen City,Guangdong Province,P.R.China

SAA XXXXXX
VDE0126-1-1,VDE-AR-N4105,G59/3,IEC61727,
IEC62116,C10/11,RD1699,UTE C15-712-1,AS4777

SOFAR SOLAR Solar Grid-tied Inverter

Model No. **SOFAR 33000TL-G2**

Max.DC input Voltage	1100V
Operating MPPT voltage range	230V ~ 960V
Max. Input current	30A/30A
Max. PV Isc	37.5A/37.5A
Nominal Grid Voltage	3/N/PE, 400Vac
Max. Output Current	3x53A
Nominal Grid Frequency	50Hz/60Hz
Nominal Output power	33000W
Max. Output power	36300VA
Power factor	>0.99(adjustable+/-0.8)
Ingress protection	IP65
Operating Temperature Range	-25--+60°C
Protective Class	Class I

Manufacturer:Shenzhen SOFARSOLAR Co., Ltd.
Address:5/F,Building 4,Antongda Industrial park,NO.1 Luxian Avenue,Xin'an Street,Bao'an District,Shenzhen City,Guangdong Province,P.R.China

SAA XXXXXX
VDE0126-1-1,VDE-AR-N4105,G59/3,IEC61727,
IEC62116,C10/11,RD1699,UTE C15-712-1,AS4777



Do not work on this equipment until it is isolated from both mains and on-site generation supplies

Note:

1. The above markings are the minimum requirements required by the safety standard. For the final production samples, the additional markings which do not give rise to misunderstanding may be added.
2. Label is attached on the side surface of enclosure and visible after installation.

EN50438			
Cl.	Requirement - Test	Result	Verdict
4	Technical requirements		P
4.1	Electrical installation		N/A
4.1.1	General		N/A
	Low voltage electrical installations shall comply with national and local regulation. In case of any hardware malfunctioning, disconnection is required.	Shall be complied with end installation	N/A
4.1.2	Over-current protection		N/A
	The micro-generating plant shall be protected against over-current according to the HD 60364 series. When selecting the over-current protection within the domestic installation it is necessary to ensure correct selectivity with the DSO' s protection devices.	Shall be complied with end installation	N/A
4.1.3	Earthing	Shall be complied with end installation	N/A
	Earthing shall be according to HD 60364-5-551 and the relevant national standards.		N/A
	When a micro-generator is operating in parallel with the distribution network, there shall be no direct connection between the generator winding (or pole of the primary energy source in the case of a DC sourced micro-generator) and the DSO' s earth terminal. For installations where the customer provides his own earth terminal, e.g. when connected to a TT system, it is also advisable to avoid connecting the generator winding to this earth terminal.		N/A
	For a micro-generator which is designed to operate in parallel with a distribution network but which is connected via an inverter (e.g. a PV array or a stationary fuel cell power system) it is permissible to connect one pole of the DC side of the inverter to the distribution network if there is insulation between the AC and the DC sides of the inverter. In such cases, the installer/manufacturer shall take all reasonable precautions to ensure that the micro-generator will not impair the integrity of the distribution network and will not suffer unacceptable damage for all credible operating conditions, including faults on the distribution network.		N/A
4.2	Normal operating range		P
4.2.1	General		P

EN50438			
Cl.	Requirement - Test	Result	Verdict
	Generating plants have to be able to operate in the operating range specified below regardless the topology and the settings of the interface protection.		P
4.2.2	Continuous voltage operation range		P
	The generating plant shall be capable not to disconnect due to voltage when the voltage at the point of connection stays within the range of $0,85 U_n$ to $1,1 U_n$.		P
	The generating plant owner shall take into account the voltage rise and voltage drop within the installation when considering the wider operating range for the generator unit itself.		P
4.2.3	Continuous frequency operation range		P
	The generating plant shall be capable to operate continuously when the frequency at the point of connection stays within the range of 49 Hz to 51 Hz.		P
	Linear generators, coupled directly and synchronously to the grid, and powered by free piston stirling engines are permitted to disconnect below 49,5 Hz and above 50,5 Hz.		N/A
4.2.4	Response to under-frequencies		P
	A generating plant shall be resilient to reductions of frequency at the point of connection while reducing the maximum power as little as possible.		P
	Table 1 shows the minimum time periods a generating plant has to be able to operate without disconnecting from the network.	See appended table	P
	The admissible active power reduction due to under-frequency below 49,5 Hz is limited by a reduction rate of 10 % of the momentary power P_M per 1 Hz frequency drop as given by the full line in Figure 2.	See appended table	P
	Respecting the legal framework, it is possible that a more stringent power reduction characteristic is required by the DSO in coordination with the TSO. Nevertheless this requirement shall be limited to an admissible active power reduction due to under-frequency below 49,0 Hz with a reduction rate of 2 % of the momentary power P_M per 1 Hz frequency drop as indicated by the dotted line in Figure 2.		P
	Acceptance of this reduction is limited to a selection of affected generation technologies and may be subject to further conditions decided by the relevant TSO.		P
4.2.5	Power response to over-frequency		P
	A generating plant shall be resilient to over-frequency at the point of connection.		P

EN50438			
Cl.	Requirement - Test	Result	Verdict
	Table 2 shows the minimum time periods a generating plant has to be able to operate without disconnecting from the network.	See appended table	P
	Unless otherwise required by the DSO, the micro-generating plant shall be capable of activating activepower frequency response at a programmable frequency threshold f_1 at least between and including 50,2 Hz and 52 Hz with a programmable droop in a range of at least 2 % – 12 %. The droop is relative to P_M , the actual AC output power at the instance when the frequency reaches the threshold f_1 . The resolution of the frequency measurement shall be +/- 10 mHz or less. After the programmable intentional delay, the active power frequency response shall be delivered with an accuracy of $\pm 10\%$ P_n and with a settling time less than 2 s.	The default Threshold f_1 setting to 50.2Hz with programmable droop 5%	P
	The generator shall be capable of activating active power frequency response as fast as technically feasible with an initial delay that shall be as short as possible with a maximum of 2 s. If the initial delay is below 2 s an intentional delay shall be programmable to adjust the total response time to a value between the initial response time and 2 s.	Intentional delay is setting to 0s	P
	After activation, the frequency droop function shall use the actual frequency at any time.		P
	If the initial delay is greater than 2 s it shall be reasonably justified by the manufacturer to the DSO.		N/A
	The settings for the threshold frequency f_1 , the droop and the intentional delay are provided by the DSO and shall be field adjustable. If no settings are provided, the default settings in Table 3 shall be applied.	It can be filed adjustable accessed by communication port RS 485	P
	For field adjustable settings means shall be provided to protect the settings from unpermitted interference (e.g. password or seal) if required by the DSO.	Authority to use	P
	When applying active power response to over-frequency, the frequency threshold f_1 should be set to a value from 50,2 Hz up to 50,5 Hz.	Setting of 50.2Hz	P
	It shall be taken into account that, in case of islanding, a power reduction would correct any excess of generation leading to a generation-consumption balance. In these circumstances, an islanding situation with stable frequency would take place, in which the correct behaviour of any LoM detection based on frequency as those mentioned in 4.6.2 (Table 4) might be hindered.		P

EN50438			
Cl.	Requirement - Test	Result	Verdict
	Generators for which it is technically not feasible to reduce power over the full droop range in the required time shall activate active power frequency response as above in the fast controllable range of output power. Once the limit of fast controllable frequency response is reached, this power level is maintained constant. The unit has to shut off at a random frequency between the frequency threshold f_1 and f_{max} ; with f_{max} the disconnection limit for over-frequency as provided by the DSO. If no setting is provided, the default setting for f_{max} is 51,5 Hz.	The default setting for f_{max} is 51.15Hz	P
	After European Network Codes will come into force, the decision about the ability should be according to the derogation process.		P
	The overall effect on transmission network level of multiple units with the random frequency disconnection function should emulate the droop curve given by Table 1 resp. the setting in Annex A.		P
	After a frequency excursion, once the frequency drops below the threshold frequency f_1 the microgenerating plant is allowed to rise the power above P_M . The active power generated by a generating plant shall not exceed the specified gradient expressed as a percentage of the active nominal power of the unit per minute. If no gradient is specified by the DSO, the default setting is 10 % P_n/min . Nonadjustable or partly adjustable generating plant that have been disconnected shall reconnect according to 4.7.2.	the default setting is 10 % P_n/min	P
4.3	Reactive power capability		P
4.3.1	Inverter based micro-generator		P
	The micro-generator shall be capable to operate, under normal stationary operating conditions in the voltage tolerance band according to 4.2.2, with the following reactive power exchange (see Figure 3):		P
	<ul style="list-style-type: none"> following a characteristic curve provided by the DSO (see 4.4) within the active factors $\cos \varphi = 0,90_{under-excited}$ to $0,90_{over-excited}$ when the active power output of the micro-generator is more than or equal to 20 % of its nominal active power; 		P
	<ul style="list-style-type: none"> not exchanging more reactive power than 10 % of the micro-generator's nominal active power when the active power output is less than 20 % of its nominal active power. 		P
4.3.2	Directly coupled micro-generator with no inverter		N/A

EN50438			
Cl.	Requirement - Test	Result	Verdict
	The power factor of the micro-generator at normal steady-state operating conditions across the statutory tolerance band of nominal voltage shall be above 0,95, provided the output active power of the micro-generator is above 20 % the nominal output power of the unit. Below 20 % nominal output power the micro-generator shall not exchange more reactive power than 10 % of its nominal active output power.		N/A
4.4	Reactive power control modes	See appended table	P
4.4.1	General		P
	Only when a reactive power exchange capability following a characteristic curve is required (see 4.3), the requirements of 4.4.3 shall apply.		P
	The control shall be delivered at the terminals of the micro-generator. The micro-generator shall be capable of operating in the following control modes within the limits stated in 4.3:		P
	Q (U)	Under consideration	P
	Cos φ fix		P
	Cos φ (P)		P
	The configuration of the control modes shall be field adjustable. The activation and deactivation of the control modes shall be field adjustable.		P
	For field adjustable configurations and activation/deactivation of the control mode, means shall be provided to protect the settings from unpermitted interference (e.g. password or seal) if required by the DSO.		P
	The accuracy for controlled reactive power shall be below $\pm 2\%$ of nominal power of the microgenerator. The accuracy is always stated in reactive power, even if the used control mode is referring to the active factor.		P
	The type of contribution to voltage control by reactive power shall be specified by the DSO. If no characteristic curve is specified by the DSO, the micro-generator shall operate with an active factor = 1.		P
4.4.2	Fix control mode cos φ		P
	The fix control mode controls the active factor cos φ of the micro-generator's output according to a setpoint set in the control of the micro-generator.		P
4.4.3	Voltage related control mode Q(U)		P
	The voltage related control mode Q(U) controls the reactive power output as a function of the voltage.		P

EN50438			
Cl.	Requirement - Test	Result	Verdict
	For evaluating the voltage one of the following methods shall be used:		P
	<ul style="list-style-type: none"> the positive sequence of the symmetrical components; 		N/A
	<ul style="list-style-type: none"> the average voltage of a three phase system; 		P
	<ul style="list-style-type: none"> phase independently the voltage of every phase to determine the reactive power for every phase. 		N/A
	A characteristic curve according to Figure 4 shall be configurable.		P
	Additional to the characteristic the dynamic response of the control should be configurable. The dynamics of the control should correspond with a first order filter having a time constant that is configurable in the range of 3 s to 60 s. The time to reach 95 % of a new set point due to a change in voltage will be 3 times the time constant.		P
4.4.4	Power related control mode Cos ϕ (P)		P
	The power related control mode Cos ϕ (P) controls the active factor Cos ϕ of the micro-generator's output as a function of its active power output.		P
	A characteristic according to Figure 4 has to be configurable.		P
	New set values due to a change of the active power output have to be adjusted within a settling time of 10 s. The rate of change of reactive power should be in the same time range as and synchronized with the rate of change of active power.		P
4.5	Voltage control by active power		P
	In order to avoid disconnection due to the over-voltage protection the micro-generating plant is allowed to reduce active power output as a function of this rising voltage. If this function is activated, the micro-generating plant may reduce active power according to a logic chosen by the manufacturer. Nevertheless, this logic shall not result in steps of output power.		P
4.6	Interface protection	Integral to the micro-generator	P
4.6.1	General		P
4.6.1.1	Introduction		P

EN50438			
Cl.	Requirement - Test	Result	Verdict
	The purpose of the interface protection is to ensure that the connection of a micro-generator will not impair the integrity or degrade the safety of the distribution network. The interface protection shall be insensitive to voltage and frequency variations in the distribution network within the voltage and frequency settings.		P
	The interface protection, monitoring and control functions may be incorporated into the microgenerator control system, or may be fitted as discrete separate mounted devices.		P
	The interface protection settings shall be field adjustable.	Accessed by communication ports	P
	For field adjustable settings means shall be provided to protect the settings from unpermitted interference (e.g. password or seal) if required by the DSO.		P
	The protection functions have to evaluate at least all phases where micro-generators, covered by this protection system, are connected to.		P
	In case of three phase generating units/plants and when the protection system is implemented as a external protection system in a three phase supply system, all phase to phase or all phase to neutral voltages have to be evaluated.		P
	The frequency has to be evaluated on at least one of the supply voltages.		P
	If multiple signals (e.g. three phase to phase voltages) are to be evaluated by one protection function, this function has to evaluate all of the signals separately. The output of each evaluation has to be OR connected, so that if one signal passes the threshold of a function, the function has to trip the protection in the specified time.		P
	The minimum required accuracy is:		P
	<ul style="list-style-type: none"> • for frequency measurement $\pm 0,05$ Hz; 		P
	<ul style="list-style-type: none"> • for voltage measurement ± 1 % of U_n. 		P
	The measurement point can be inside the micro-generator or anywhere between the micro-generator terminals and up to the point of connection.		P
	If the interface protection system is external to the generating unit, it should measure as close as possible to the point of connection. The voltage rise between the point of connection and the measurement input of the interface protection system should be kept as small as possible to avoid nuisance tripping of the overvoltage protection.	Internal of inverter	N/A

EN50438			
Cl.	Requirement - Test	Result	Verdict
	In order to avoid continuous starting and disengaging operations of the interface protection relay, the disengaging value of frequency and voltage functions shall be above 2 % deviating from the operate value.		N/A
4.6.1.2	Response to protection operation		P
	The micro-generator shall disconnect from the network in response to an interface protection operation.		P
4.6.1.3	Place of the interface protection		P
	The interface protection can either be incorporated within the micro-generator or implemented by separate devices. In either case, the interface protection shall meet the relevant requirements of IEC 60255-127 and the manufacturer of the micro-generator shall declare that the combined devices fulfil these requirements.	incorporated within the micro-generator	P
4.6.1.4	Changing settings of the interface protection		P
	The interface protection settings may only be altered from the settings chosen at the time of commissioning or during later reconfiguration, with the written agreement of the DSO and then only in accordance with the manufacturer instructions. It shall not be permissible for the user to alter the interface protection settings.		P
4.6.1.5	Combined protection device for multiple generators		N/A
	It is allowed to use a protection system that provides interface protection for two or more microgenerators up to and including 16 A per phase in aggregate. However, the possibility to use Inform and Fit then depends on the conditions of the type of conformity assessment of the protection system.		N/A
	If two or more micro-generators, each with their own interface device, are placed in parallel, the proper combined working of the protection devices shall be ensured.		N/A
	In the case of adding a generator to the combined protection device, the DSO shall be consulted.		N/A
4.6.2	Interface protection settings		P
	The interface protection settings are provided by the DSO. If no settings are provided, the default settings in Table 4 should be applied.		P
4.6.3	Requirements regarding single fault tolerance of interface protection system		P

EN50438			
Cl.	Requirement - Test	Result	Verdict
	The interface protection system consisting of the interface protection relay and the interface switch shall meet the requirements of single fault tolerance.	Single fault condition have been considered	P
	A single fault shall not lead to a loss of the safety functions. Faults of common cause shall be taken into account if the probability for the occurrence of such a fault is significant. Whenever reasonably practical, the individual fault shall be displayed and lead to the disconnection of the power generation unit or system.		P
	Series-connected switches shall each have independently a breaking capacity corresponding to the rated current of the micro-generator and corresponding to the short circuit contribution of the microgenerator.		P
	The short-time withstand current of the switching devices shall be coordinated with maximum short circuit power at the connection point.		P
	At least one of the switches shall be a switch-disconnector suitable for over-voltage category 2. For single-phase micro-generators, the switch shall have one contact of this over-voltage category each for both the neutral conductor and the line conductor. For poly-phase supply systems, it is required to have one contact of this over-voltage category each for all active conductors. The second switch may be formed by electronic switching components of an inverter bridge or another circuit provided that the electronic switching components can be switched off by control signals and that it is ensured that a failure is detected and leads to prevention of the operation at the latest at the next reconnection.	Relay is used as disconnecter suitable for over-voltage category 2 See CE report for details	P
	For PV-inverters without simple separation between the network and the PV generator (e.g. PV inverter without transformer) both switches mentioned in the paragraph above shall be switch disconnectors with the requirements described therein, although one switching device is permitted to be located between PV generator and PV inverter.		N/A
4.7	Connection and starting to generate electrical power		P
4.7.1	General		P

EN50438			
Cl.	Requirement - Test	Result	Verdict
	Connection and starting to generate electrical power is only allowed after voltage and frequency is within the allowed voltage range and the allowed frequency range for at least the specified observation time. It shall be impossible to overrule these conditions. The setting of the conditions depends on whether the connection is due to a normal operational start-up or an automatic reconnection after tripping of the interface protection.		P
	The frequency range, the voltage range, the observation time and the power gradient shall be field adjustable.		P
	For field adjustable settings, means shall be provided to protect the settings from unpermitted interference (e.g. password or seal) if required by the DSO.		P
4.7.2	Automatic reconnection after tripping		P
	If no settings are specified by the DSO, the default settings for the reconnection after tripping of the interface protection are:		P
	• Frequency range: $47,5 \text{ Hz} \leq f \leq 50,05 \text{ Hz}$	See appended table	P
	• Voltage range: $0,85U_n \leq U \leq 1,10U_n$	See appended table	P
	• Minimum observation time: 60 s	180 s	P
	After reconnection the active power generated by the generating plant shall not exceed a specified gradient expressed as a percentage of the active nominal power of the unit per minute. If no gradient is specified by the DSO, the default setting is 10 % P_n/min . Non-adjustable or partly adjustable generating units may connect after 1 min to 10 min (randomised value) or later.	The default setting is 10 % P_n/min	P
4.7.3	Starting to generate electrical power		P
	If no settings are specified by the DSO the default settings for connection or starting to generate electrical power due to normal operational start-up or activity are:		P
	• Frequency range: $47,5 \text{ Hz} \leq f \leq 50,1 \text{ Hz}$	See appended table	P
	• Voltage range: $0,85U_n \leq U \leq 1,10U_n$	See appended table	P
	• Minimum observation time: 60 s	180 s	P
	If applicable, the power gradient shall not exceed the maximum gradient specified by the DSO in the connection agreement. Heat driven CHP micro-generators do not need to keep a maximum gradient, since the start up is randomised by the nature of the heat demand.	The default setting is 10 % P_n/min	P

EN50438			
Cl.	Requirement - Test	Result	Verdict
	For manual operations performed on site (e.g. for the purpose of initial start-up or maintenance) it is permitted to deviate from the observation time and ramp rate.		N/A
4.7.4	Synchronisation		P
	Synchronising a micro-generator with the distribution network shall be fully automatic i.e. it shall not be possible to manually close the switch between the two systems to carry out synchronisation.		P
4.8	Power quality		P
4.8.1	General		P
	As any other apparatus or fixed installation, micro-generators have to comply with the requirements on electromagnetic compatibility established in Directive 2004/108/EC.		P
	They are also expected to be compatible with voltage characteristics at the point of connection to the public network, as described in 4.2.		P
	As long as specific tests for generators are not available, generic EMC standards, regarding immunity as well as emission, should be applied. The applicable standards, which in turn describe the test in accordance with basic standards (EN 61000-3, all parts, and EN 61000-4, all parts), are:		P
	<ul style="list-style-type: none"> Immunity: EN 61000-6-1 (residential, commercial and light-industrial environments); 		P
	<ul style="list-style-type: none"> Emission: EN 61000-6-3 (residential, commercial and light-industrial environments): in this generic emission standard reference is made to e.g. the harmonics and voltage variation basic standards listed in Table 5. 		P
	In addition, the application of the requirements and tests described in IEC/TR 61000-3-15 is recommended, with the exception of those aspects already regulated by specific national rules.		P
	Generating plants can also disturb mains signaling (ripple control or power line carrier systems). EMC requirements on inter-harmonics and on conducted disturbances in frequency range between 2 kHz and 150 kHz are under development. In countries where such communication systems are used, national requirement may apply.		P
4.8.2	DC injection		P
4.8.2	The generating unit shall not inject a direct current.	See appended table	P

EN50438			
Cl.	Requirement - Test	Result	Verdict
5	Operation and safety of the micro-generator		P
5.1	General		P
	The micro-generator shall operate safely over the entire designed and declared operating range.		P
	The settings of (country-specific) field adjustable set-points shall be readable from the microgenerator, for example on a display panel, user interface, or via a communication port.	Via a communication port	P
5.2	Safety		P
	This European Standard does not cover the safety of DSO personnel or their contracted parties, as their safety is a combination of electrical conditions and working instructions.		P
	General requirements for safety of persons at work in or near and operation of electrical installations are given in EN 50110 (all parts), also national regulations can be applicable.		P
5.3	Information plate		P
	In absence of product specific standards (e.g. EN 50524) the following information shall appear on the micro-generator nameplate:		P
	<ul style="list-style-type: none"> • manufacturer's name or trade mark; 		P
	<ul style="list-style-type: none"> • type designation or identification number, or any other means of identification making it possible to obtain relevant information from the manufacturer; 		P
	<ul style="list-style-type: none"> • nominal power; 		P
	<ul style="list-style-type: none"> • nominal voltage; 		P
	<ul style="list-style-type: none"> • nominal frequency; 		P
	<ul style="list-style-type: none"> • phases; 		P
	<ul style="list-style-type: none"> • active factor range or, if no active factor is adjustable, the minimal power factor. 		P
	This information shall be provided on a plate on or in the micro-generator and shall be copied in the user manual as well as other related documentation. In addition, a serial number may be added to the plate only.		P
	This information could be part of the information plate of the entire micro-generator system.		P
	All the information shall be given in the language and in accordance with the practice of the country in which the micro-generator is intended to be installed or alternatively in English language.	English language	P

EN50438			
Cl.	Requirement - Test	Result	Verdict
5.4	Labelling		P
	A warning notice shall be placed in such a position that any person gaining access to live parts will be warned in advance of the need to isolate those live parts from all points of supply.	Shall be noted in the field	P
	Special attention should be paid that the power supply, measuring circuits (sense lines) and other parts may not be isolated from the network when the switch of the interface protection is open.		P
	As a minimum, warning labels shall be placed:		P
	<ul style="list-style-type: none"> on the switchboard (DSO panel and consumer unit) that has the micro-generator connected to it; 		P
	<ul style="list-style-type: none"> on all switchboards in between the consumer unit and the micro-generator itself; 		N/A
	<ul style="list-style-type: none"> on, or in the micro-generator itself; 		N/A
	<ul style="list-style-type: none"> at all points of isolation for the micro-generator. 		N/A
	All the information shall be given in the language and in accordance with the practice of the country in which the micro-generator is intended to be installed.		P
5.5	Maintenance and routine testing		P
	The manufacturer shall provide a time frame for maintenance and routine testing.		P
	The user is responsible for the proper maintenance and routine testing.		P
	Maintenance and routine testing shall be carried out by qualified service technicians.		P
	With respect to service technicians, additional national requirements shall be taken into account.		P
6	Commissioning		P
	This European Standard applies to type-tested micro-generators.		P
	The following conditions shall be met for the installation:		P
	the micro-generator (including the interface protection) shall fulfil the requirements of this standard and the other applicable standards;		P
	the manufacturer shall provide an installation instruction in accordance with this standard and national or regional requirements;		P
	access to the interface protection settings shall be tamper-proof;		P
	in the absence of product standards the micro-generator shall be type tested against the interface requirements of this standard;		P

EN50438			
Cl.	Requirement - Test	Result	Verdict
	the installation shall be carried out by installers with recognised and approved qualification related to the fuels used, general electrical installations and a particular qualification relating to installation of micro-generators;		P
	the installer shall provide a single line diagram of the electricity generating facility. The single line diagram shall show the circuit breaker, the protections, the inverter, etc.		P
	The user respective the installer should be aware that in addition to the DSO the energy supplier and/or the metering authority will need to be informed for contractual reasons.		P
	Unless otherwise stated by national legislation or regulation, prior consent of the DSO is necessary.		P
Annex A	National settings and requirements		P
A.1	General		P
A.2	AT – Austria		N/A
A.3	BE – Belgium		N/A
A.4	CY – Cyprus		N/A
A.5	CZ – Czech Republic		N/A
A.6	DE – Germany		N/A
A.7	DK – Denmark		N/A
A.8	EE – Estonia		N/A
A.9	ES – Spain		N/A
A.10	FI – Finland		N/A
A.11	FR – France		N/A
A.12	GB – United Kingdom		N/A
A.13	IE – Ireland		N/A
A.14	IT – Italy		N/A
A.15	LV – Latvia		N/A
A.16	NL – The Netherlands		N/A
A.17	NO – Norway		N/A
A.18	PL – Poland		N/A
A.19	SI – Slovenia		N/A
A.20	SE – Sweden		N/A
Annex B	Loss of Mains and overall system security		P

EN50438			
Cl.	Requirement - Test	Result	Verdict
Annex C	Example notification sheets		--
Annex D	Compliance type testing		P
D.1	General		P
D.2	Type testing of the interface protection		P
D.2.1	Introduction		P
D.2.2	General		P
D.2.3	Over-/under-voltage		P
D.2.4	Over- /under-frequency		P
D.2.5	Loss of Mains (LoM) detection		P
D.3	Type testing of a micro-generator		P
D.3.1	Operating range		P
D.3.2	Active power feed-in at under-frequency		P
D.3.3	Power response to over-frequency		P
D.3.4	Reactive power capability		P
D.3.5	Voltage control by active power		N/A
D.3.6	Connection and starting to generate electrical power		P
D.3.7	Short-circuit current contribution	Manufacturers declare the short circuit contribution in the installation manual	N/A
D.3.8	Harmonic current emission		P
D.3.9	Voltage fluctuations and flicker		P
D.3.10	DC injection		P
Annex E	Example test results sheet		--
Annex F	Commissioning		P
Annex G	Countries allowing extension of the scope > 16 A		N/A
G.1	General		N/A
G.2	CY – Cyprus		N/A
G.3	FI – Finland		N/A
G.4	IE – Ireland		N/A

Appendix A: Tables

D.2.3 Over-/under-voltage					P
		Over Voltage		Under Voltage	
Parameter		Voltage(V)	Disconnection Time(s)	Voltage(V)	Disconnection Time(s)
Protection limit		264.5V	0.5	184V	0.5
Actual setting (as applied to interface protection)		264.5V	0.4	184V	0.4
Trip value (test result)-1	All phases	264.20	0.427	182.49	0.438
	Phase R	263.36	0.427	182.31	0.438
	Phase S	263.58	0.425	182.72	0.437
	Phase T	265.69	0.424	182,44	0.438
Trip value (test result)-2	All phases	263.64	0.433	182.53	0.438
	Phase R	263.75	0.433	182.32	0.438
	Phase S	263.06	0.433	182.77	0.436
	Phase T	265.11	0.432	182.51	0.437
Trip value (test result)-3	All phases	262.68	0.435	182.50	0.449
	Phase R	262.76	0.435	182.26	0.449
	Phase S	263.02	0.433	182.79	0.447
	Phase T	265.25	0.434	182.45	0.449
Trip value (test result)-4	All phases	263.70	0.500	182.51	0.442
	Phase R	262.71	0.500	182.33	0.442
	Phase S	263.03	0.500	182.83	0.441
	Phase T	265.37	0.498	182.37	0.441

Appendix A: Tables

Trip value (test result)-5	All phases	263.57	0.471	182.40	0.438
	Phase R	262.74	0.471	182.26	0.438
	Phase S	263.15	0.470	182.79	0.437
	Phase T	264.82	0.470	182.14	0.437
Over-voltage stage 1*	253V (according to EN50160),the disconnection after detection of a overvoltage at 10 min-mean-value takes place within 3s				
*The calculation of the 10 min value tested and compliance					
	Output Voltage (V)	Switch			
		On/Off state Finally		On/Off state Finally	
100% Un	230.0	<input checked="" type="checkbox"/> On	<input type="checkbox"/> Off	Work normally	
112% Un	257.6	<input type="checkbox"/> On	<input checked="" type="checkbox"/> Off	532s	
100% Un	230.0	<input checked="" type="checkbox"/> On	<input type="checkbox"/> Off	Work normally	
108% Un	248.4	<input checked="" type="checkbox"/> On	<input type="checkbox"/> Off	Work normally	
106% Un	243.8	<input checked="" type="checkbox"/> On	<input type="checkbox"/> Off	Work normally	
114% Un	262.2	<input type="checkbox"/> On	<input checked="" type="checkbox"/> Off	283s	
*The calculation of the 10 min value tested and compliance.					
The operate values are within $\pm 1\%$ Un					
Tolerances on disconnection time are $\pm 10\%$					
The measured trip time was captured by oscilloscope, which CH2 denotes trip signal and CH10,CH12,CH14 denotes output current of EUT, CH9,CH11,CH13 enotes output voltage of EUT					

Appendix A: Tables

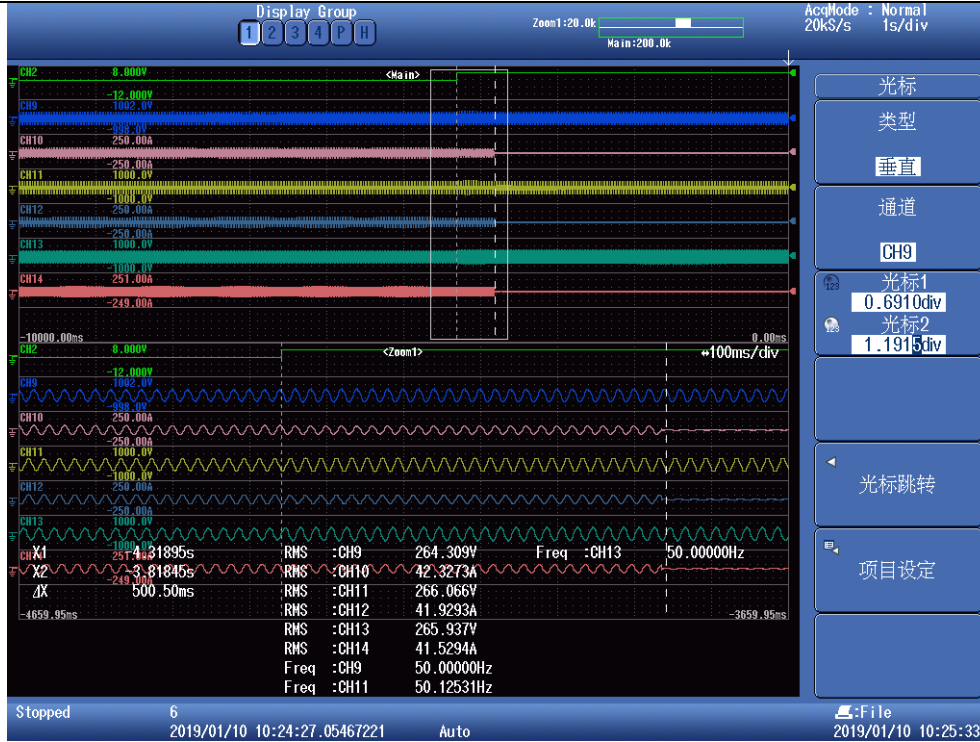

Over voltage

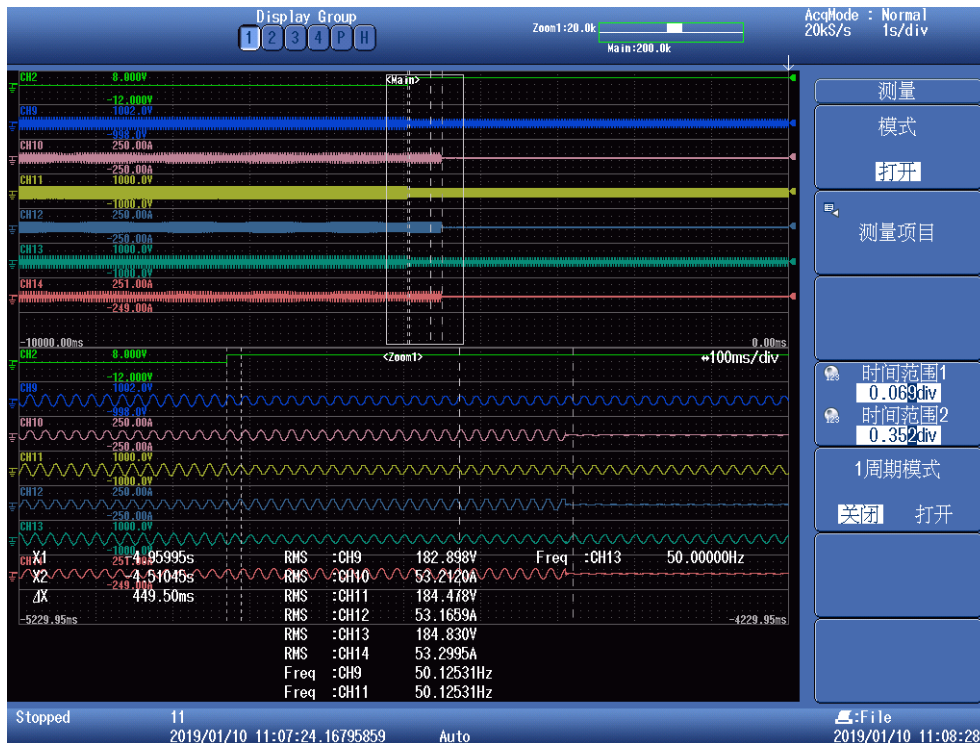

Under Voltage

Appendix A: Tables

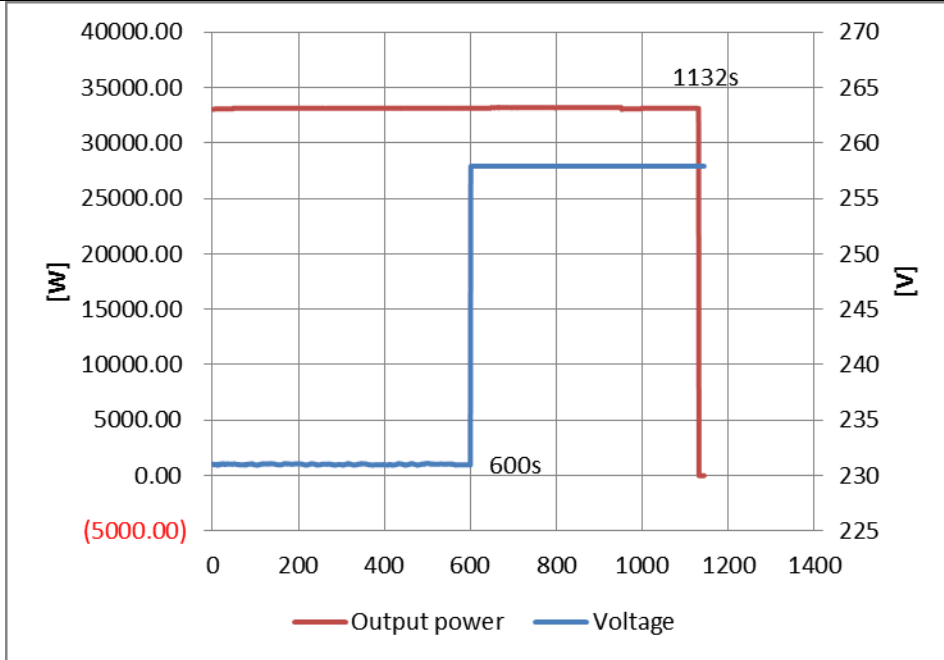

Un to 1.12Un

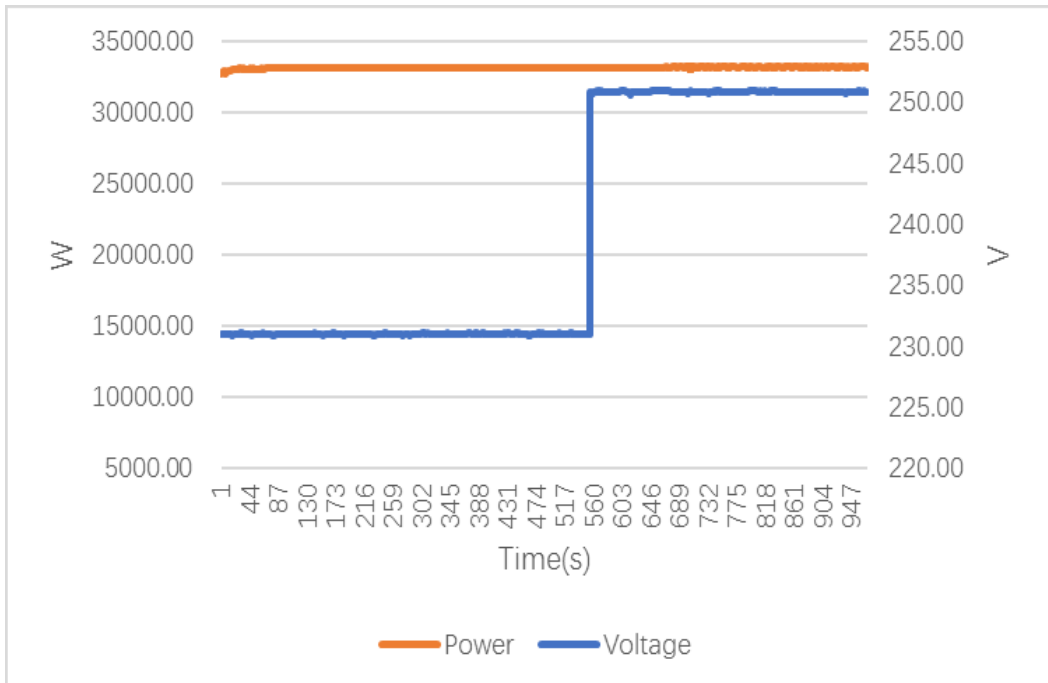

Un to 1.08Un

Appendix A: Tables

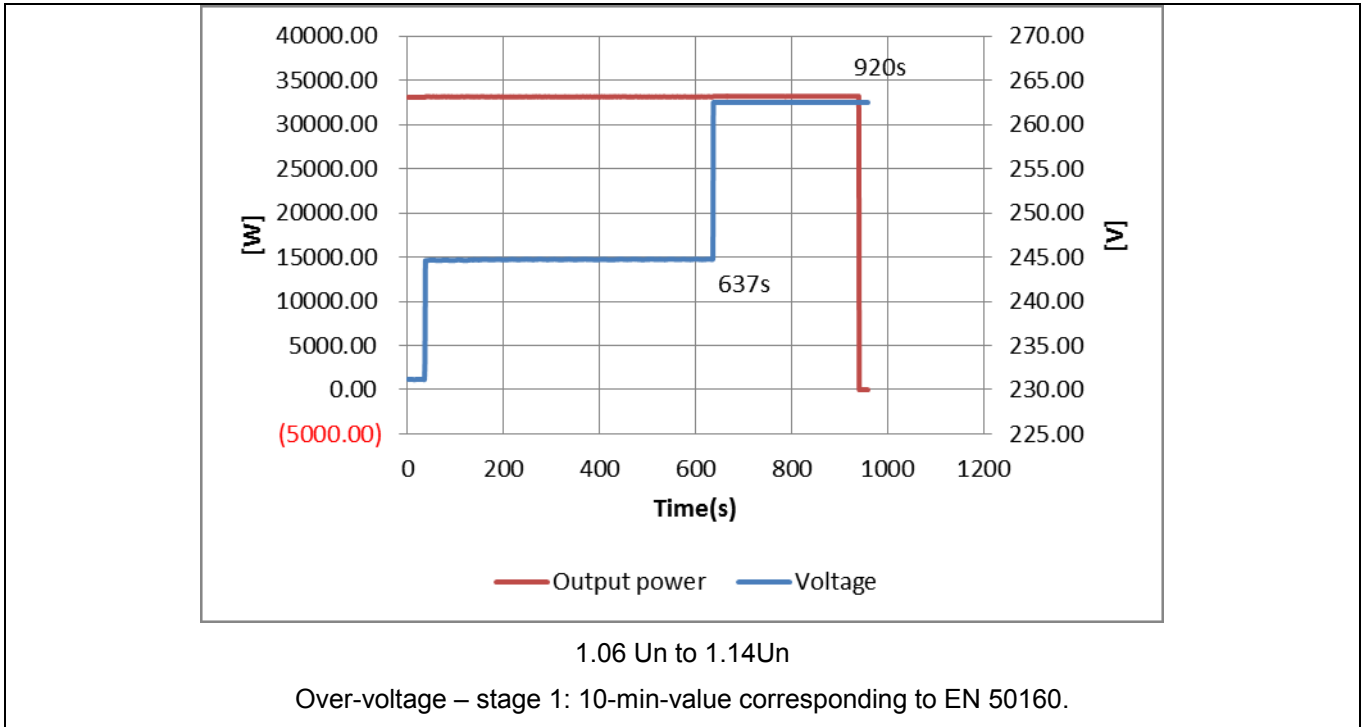

D.2.4 Over- /under-frequency (islands)				P
Parameter	Over Frequency		Under Frequency	
	Frequency	Time	Frequency	Time
Protection limit	51Hz	0.5s	47.5Hz	0.5s
Actual setting (as applied to interface protection)	51Hz	0.4s	47.5Hz	0.4s
Trip value (test result)-1	51.101Hz	0.441s	47.452 Hz	0.422s
Trip value (test result)-2	51.095Hz	0.419s	47.451 Hz	0.431s
Trip value (test result)-3	51.095Hz	0.442s	47.451 Hz	0.437s
Trip value (test result)-4	51.105Hz	0.448s	47.452 Hz	0.428s
Trip value (test result)-5	51.094Hz	0.418s	47.451 Hz	0.436s

Remark:
the operate values are within ± 0.02 Hz. tolerances on disconnection time are $\pm 10\%$.
The measured trip time was captured by oscilloscope, which CH2 denotes trip signal and CH10,CH12,CH14 denotes output current of EUT, CH9,CH11,CH13 enotes output voltage of EUT

Appendix A: Tables

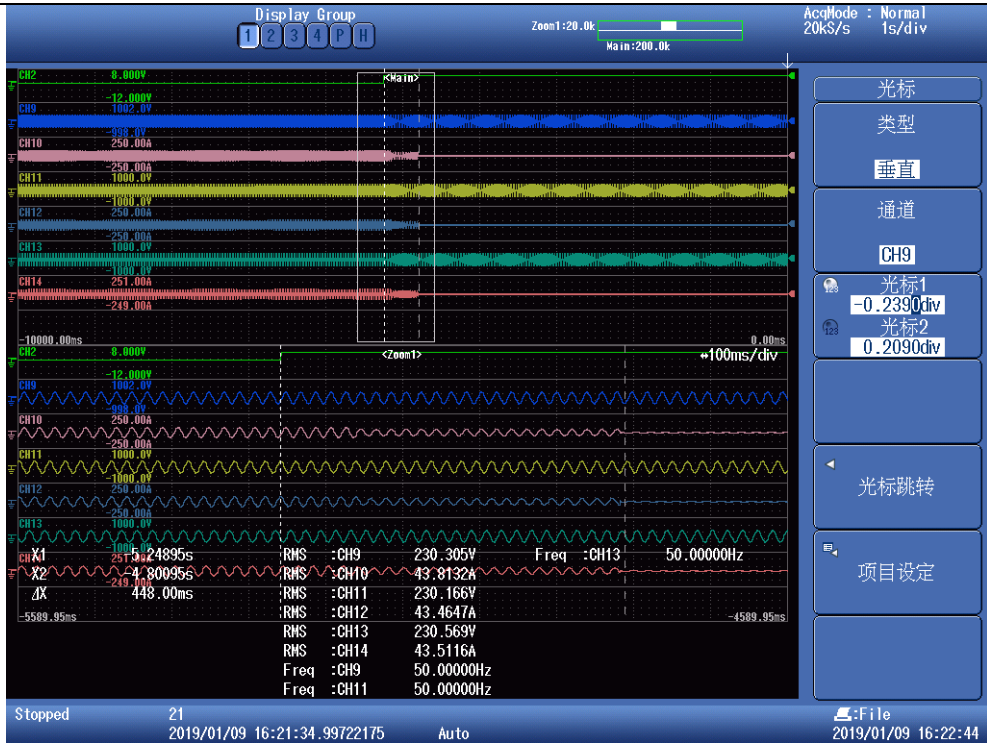

Over Frequency



Under Frequency

Appendix A: Tables

D.2.4 Over- /under-frequency(Continent)				P
Parameter	Over Frequency		Under Frequency	
	Frequency	Time	Frequency	Time
Protection limit	50.5Hz	0.5s	49.5Hz	0.5s
Actual setting (as applied to interface protection)	50.5Hz	0.4s	49.5Hz	0.4s
Trip value (test result)-1	50.603Hz	0.427s	49.401 Hz	0.426s
Trip value (test result)-2	50.605Hz	0.439s	49.402 Hz	0.439s
Trip value (test result)-3	50.604Hz	0.425s	49.402 Hz	0.436s
Trip value (test result)-4	50.604Hz	0.414s	49.403 Hz	0.420s
Trip value (test result)-5	50.601Hz	0.442s	49.401 Hz	0.443s

Remark:

the operate values are within ± 0.02 Hz. tolerances on disconnection time are $\pm 10\%$.

The measured trip time was captured by oscilloscope, which CH2 denotes trip signal and CH10,CH12,CH14 denotes output current of EUT, CH9,CH11,CH13 enotes output voltage of EUT

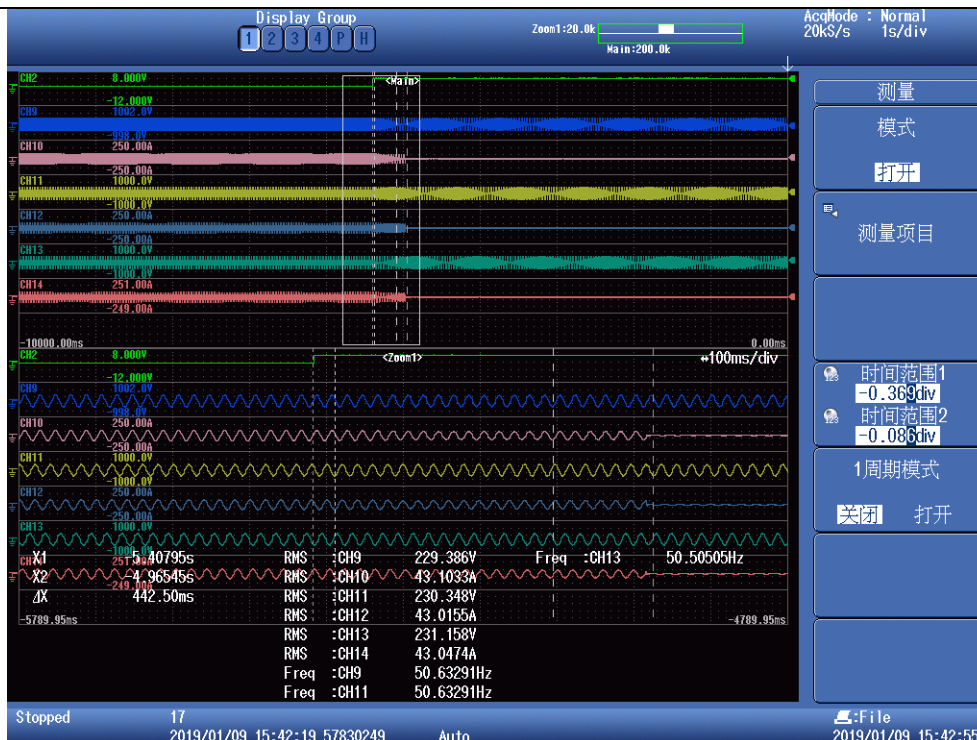

Over Frequency

Appendix A: Tables

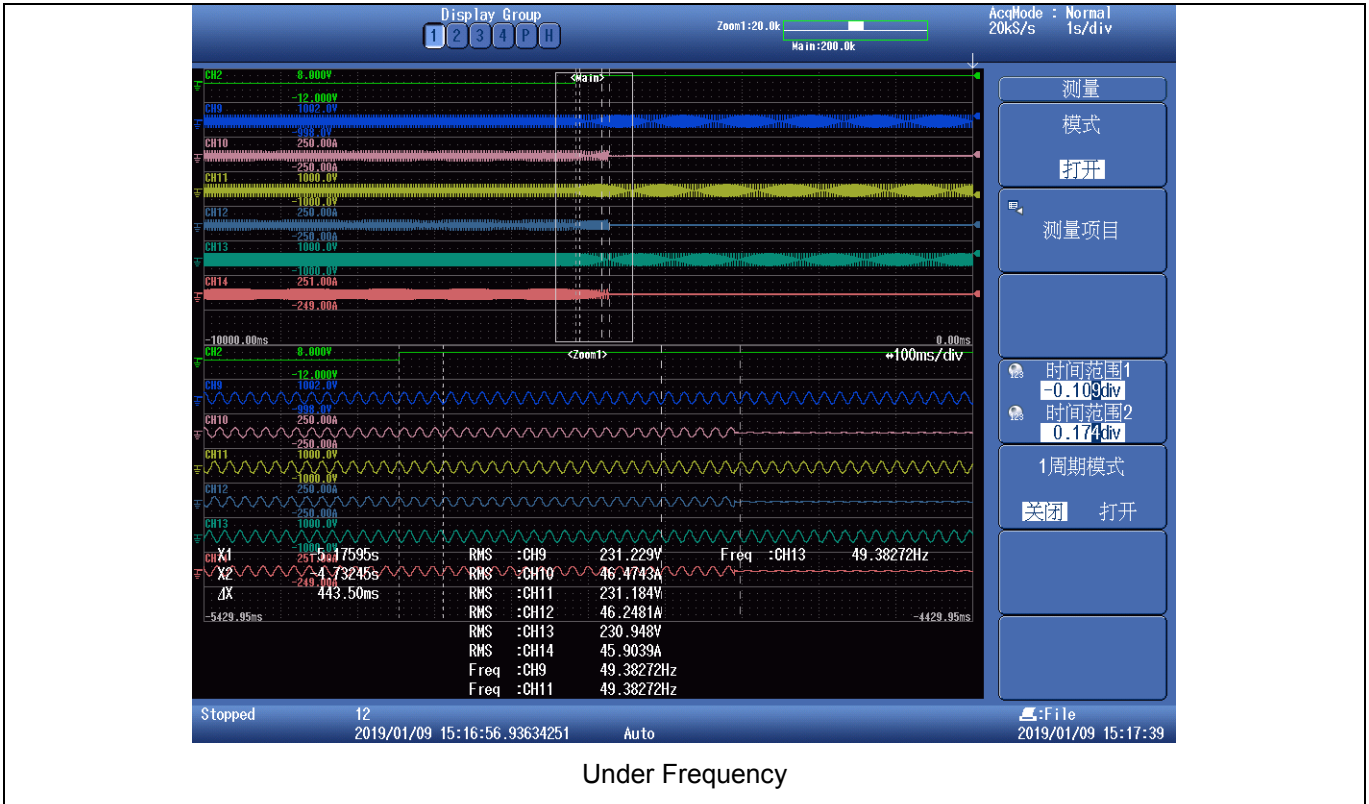

Appendix A: Tables

D.2.5		TABLE: Loss of Mains (LoM) detection (according to VDE 0126)				P
Test conditions:		Frequency: 50+/-0,2Hz U _N =230+/-3Vac RLC consumes inverter real power within +/-3% Distortion factor of chokes <3% Quality Q>2				
P = 1.0 P _N = (W)	33000W	P = 0.5 P _N = (W)	16500W	P = 0.25 P _N = (W)	8250W	
Q _L = 67.04KVar	Cut-off time (ms)	Q _L = 33.52KVar	Cut-off time (ms)	Q _L = 16.76KVar	Cut-off time (ms)	
95%	920.0	95%	976	95%	128	
96%	828.0	96%	992	96%	172	
97%	980.0	97%	1210	97%	652	
98%	920.0	98%	944	98%	920	
99%	1010.0	99%	976	99%	960	
100%	928.0	100%	1010	100%	1020	
101%	964.0	101%	976	101%	896	
102%	948.0	102%	912	102%	1030	
103%	976.0	103%	568	103%	912	
104%	944.0	104%	992	104%	976	
105%	960.0	105%	580	105%	964	

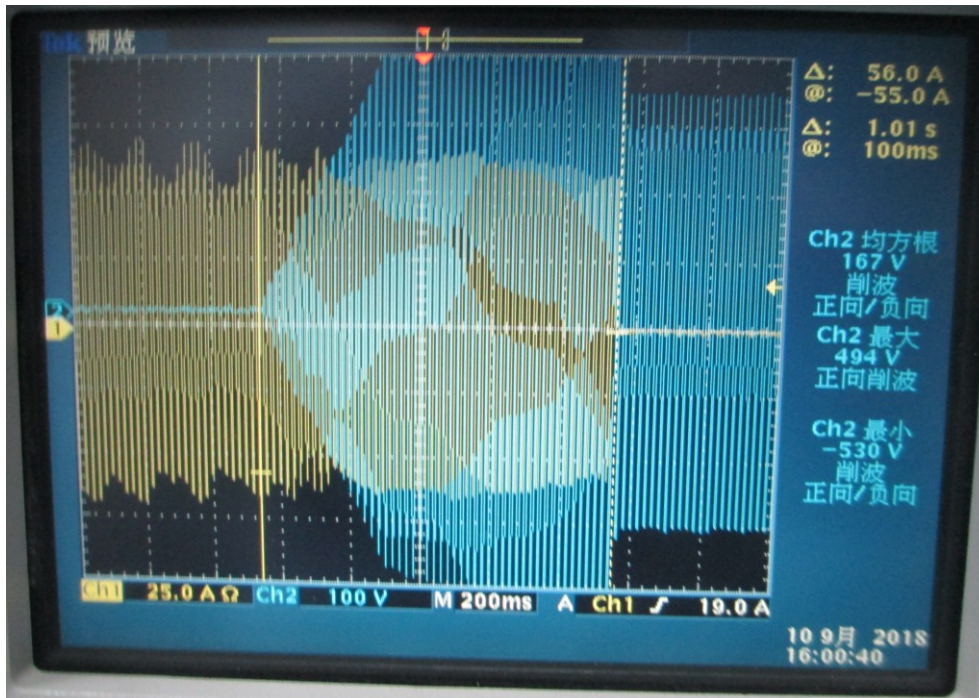

100%

Appendix A: Tables

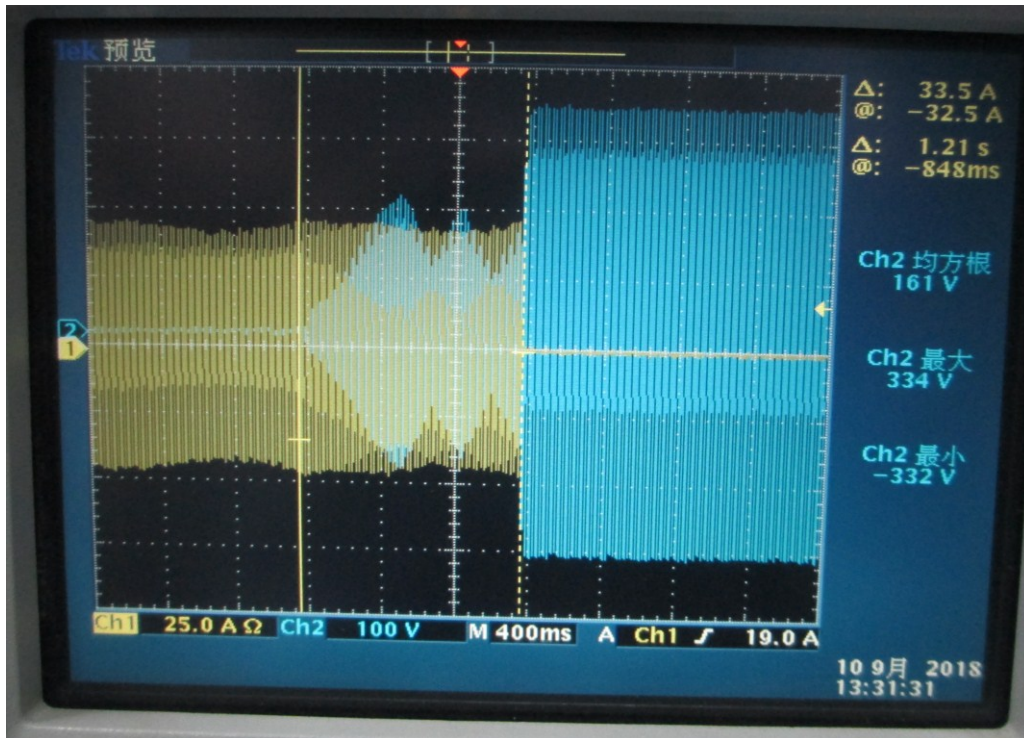

50%

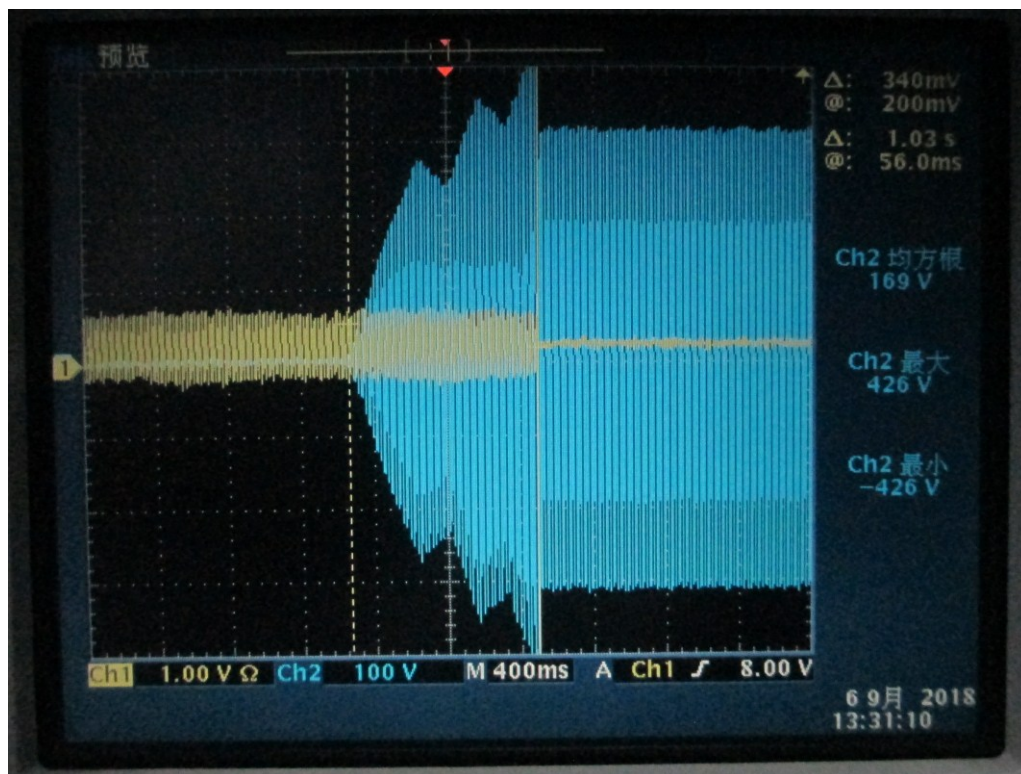

25%

Yellow: Current of output, Green: Trip signal

Appendix A: Tables

D.3.1 Operating range				P
Test sequence	Voltage	Frequency	Output power	Primary power source
Test 1	196.62	47.5	31560.66	32701.17
Test 2	254.15	51.50	33012.80	33837.20

D.3.2 Active power feed-in at under-frequency			P
Test sequence	Frequency	Output power	Primary power source
Test a)	50.0Hz	33419.47 W	33816.79
Test b)	49.5Hz	33421.90 W	33847.81
Test c)	47.5Hz	33407.64 W	33808.90

D.3.3 Power response to over-frequency				P
Test sequence at power level >80%	Output Power	Frequency	Primary Power source	Power gradient
Step a)	33085.50 W	50.00Hz	34000.00 W	--
Step b)	32432.91 W	50.25Hz	33300.00 W	--
Step c)	26454.80 W	50.70 Hz	27200.00 W	--
Step d)	16529.80 W	51.15 Hz	21000.00 W	--
Step e)	26455.30 W	50.70 Hz	27200.00 W	--
Step f)	32438.80 W	50.25 Hz	33300.00 W	--
Step g)	33069.50 W	50.00 Hz	34000.00 W	--

Remark:
Test for frequency threshold 50.2Hz with droop 5%, intentional delay is setting to 0s
the active power frequency response is delivered with an accuracy of $\pm 10\%P_n$

Appendix A: Tables

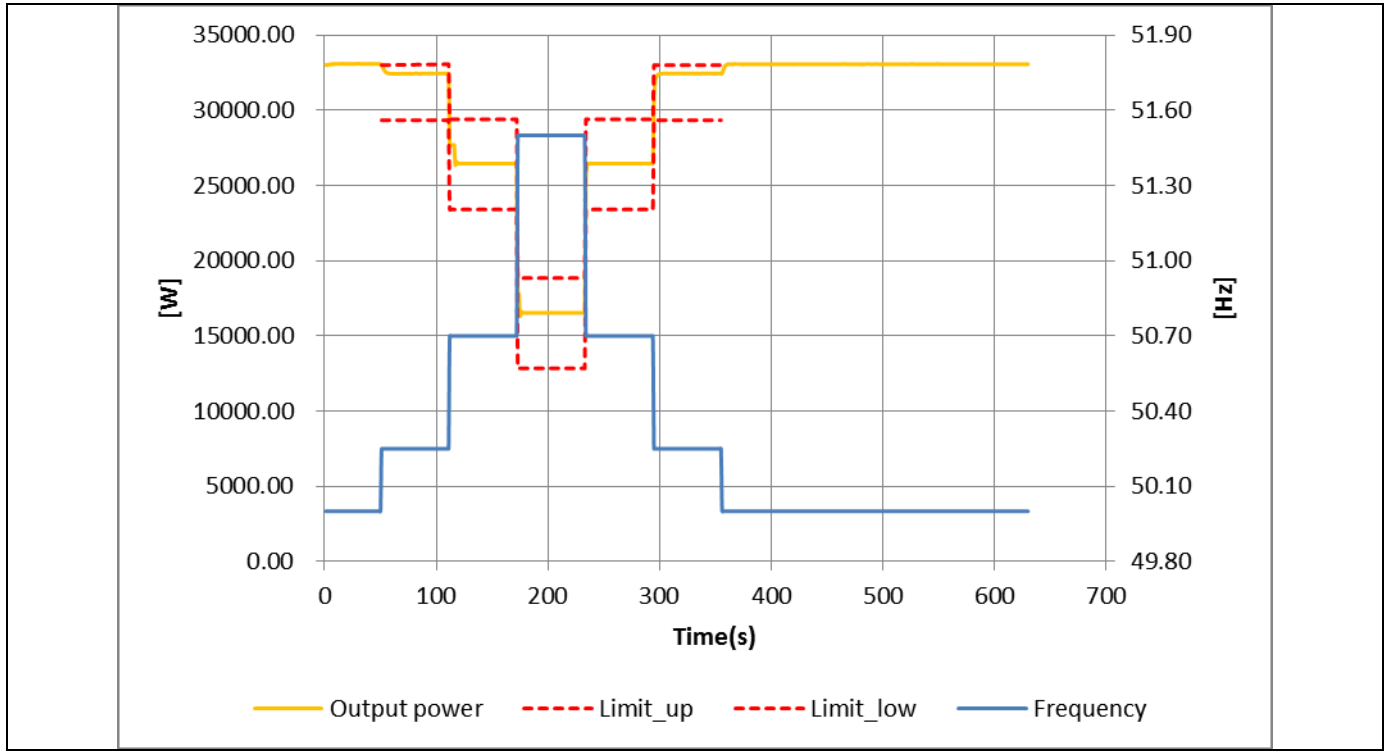

D.3.3 Power response to over-frequency				P
Test sequence at power level 40%-60%	Output Power	Frequency	Primary Power source	Power gradient
Step a)	16490.70 W	50.00Hz	16907.30 W	--
Step b)	16176.10 W	50.25Hz	16506.50 W	--
Step c)	13193.20 W	50.70Hz	13467.70 W	--
Step d)	10234.10 W	51.15Hz	10461.50 W	--
Step e)	13199.90 W	50.70Hz	13511.90 W	--
Step f)	16163.50 W	50.25Hz	16515.80 W	--
Step g)	33067.80 W	50.00Hz	33924.70 W	2885.5W/1min

Remark:
 Test for frequency threshold 50.2Hz with droop 5%, intentional delay is setting to 0s
 The active power frequency response is delivered with an accuracy of 10%Pn
 The power grade where rise the power above Pm is less than 10%Pn/min, the default setting is 10%Pn/min

Appendix A: Tables

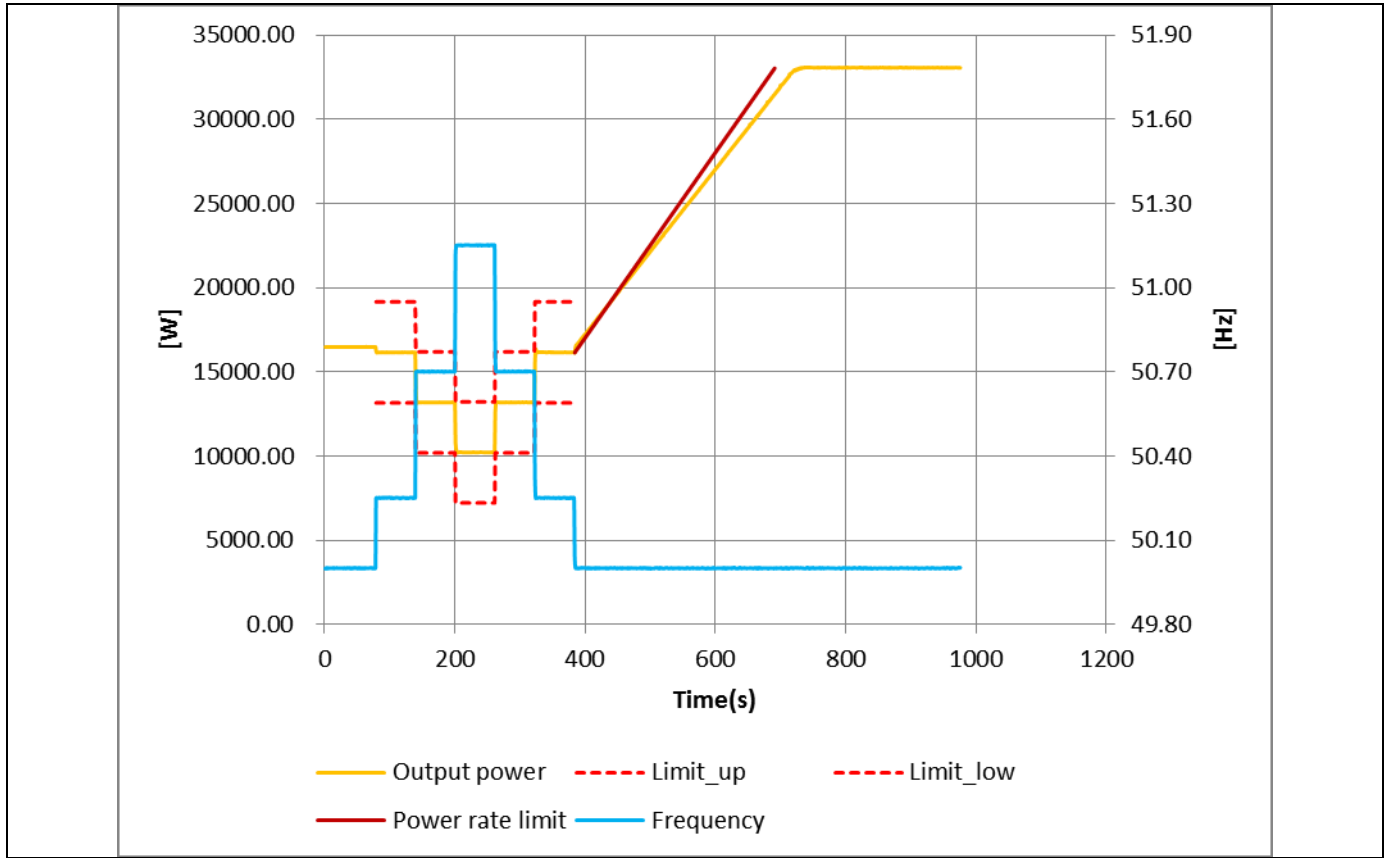

D.3.4.1 Uncontrollable reactive power			
Model: SOFAR 20000TL-G2			
Limit	Power factor		
	+ 0,95 - 0,95 at three voltage levels and four power levels		
	210V	230V	250V
20% of nominal active power	0.9838	0.9811	0.9784
50% of nominal active power	0.9971	0.9967	0.9962
75% of nominal active power	0.9983	0.9979	0.9980
100% of nominal active power	0.9996	0.9996	0.9996

Remark:
The tests performed on model SOFAR 20000TL-G2, that are representable with SOFAR 25000TL-G2, SOFAR 30000TL-G2, SOFAR 33000TL-G2

Appendix A: Tables

D 3.4.2 Reactive power output capability

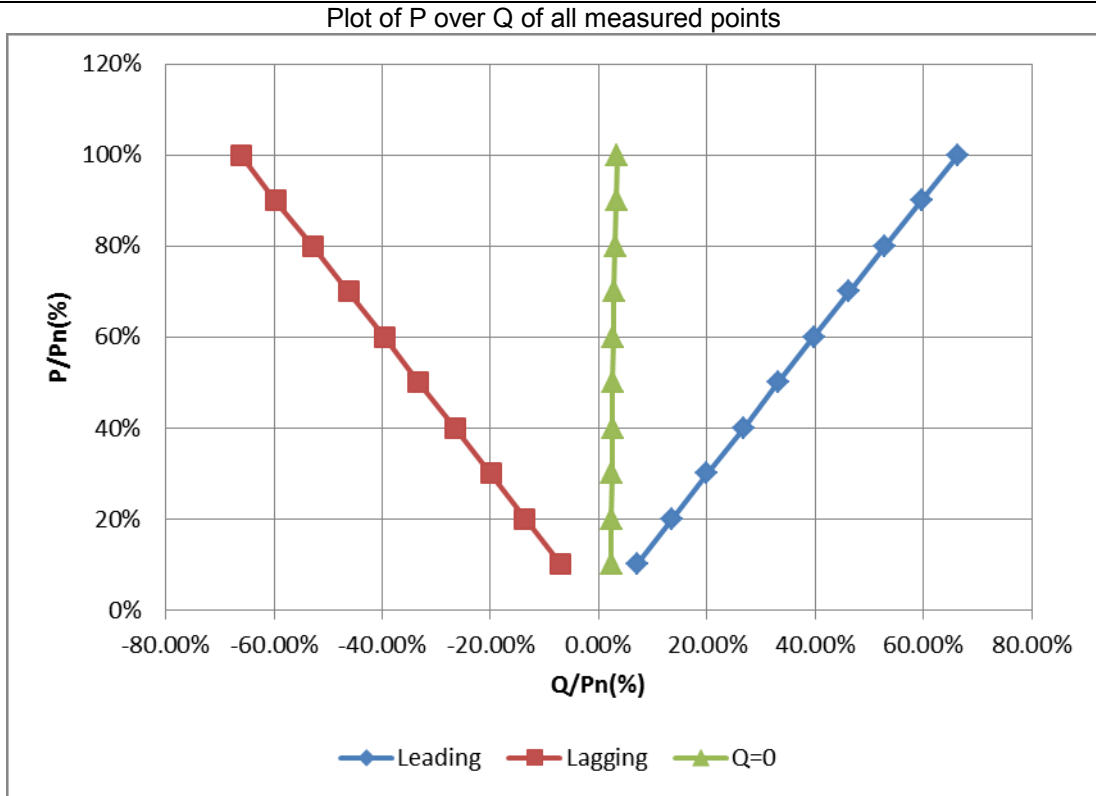

Set reactive power(Var)	Test sequence start of generation	Output power(W)	Measured reactive power(Var)	Cosφ
Max Over excited	0%-10%	2929.00	2343.15	0.7848
	10%-20%	5865.43	4472.92	0.7937
	20%-30%	8794.60	6607.51	0.8003
	30%-40%	11889.42	8872.53	0.8024
	40%-50%	14798.82	10938.18	0.8032
	50%-60%	17648.63	13127.64	0.8036
	60%-70%	20601.87	15295.98	0.8036
	70%-80%	23557.24	17458.54	0.8035
	80%-90%	26564.93	19678.53	0.8034
Max Under excited	90%-100%	29489.57	21942.99	0.8037
	0%-10%	2925.19	-2312.33	0.7803
	10%-20%	5845.22	-4494.55	0.7941

Appendix A: Tables

	20%-30%	8773.69	-6590.24	0.7988
	30%-40%	11851.45	-8745.46	0.8005
	40%-50%	14643.29	-10973.86	0.8012
	50%-60%	17584.40	-13071.86	0.8013
	60%-70%	20527.00	-15257.94	0.8018
	70%-80%	23463.32	-17449.62	0.8022
	80%-90%	26446.41	-19686.76	0.8022
	90%-100%	29427.42	-21830.68	0.8017
Q=0	0%-10%	2927.84	770.02	0.9671
	10%-20%	5864.05	782.87	0.9912
	20%-30%	8795.99	805.87	0.9958
	30%-40%	11729.34	835.93	0.9975
	40%-50%	14666.24	869.12	0.9982
	50%-60%	17605.94	908.19	0.9987
	60%-70%	20546.90	952.38	0.9989
	70%-80%	23492.12	1005.14	0.9991
	80%-90%	26430.64	1075.79	0.9992
	90%-100%	32904.21	1109.90	0.9994

Appendix A: Tables

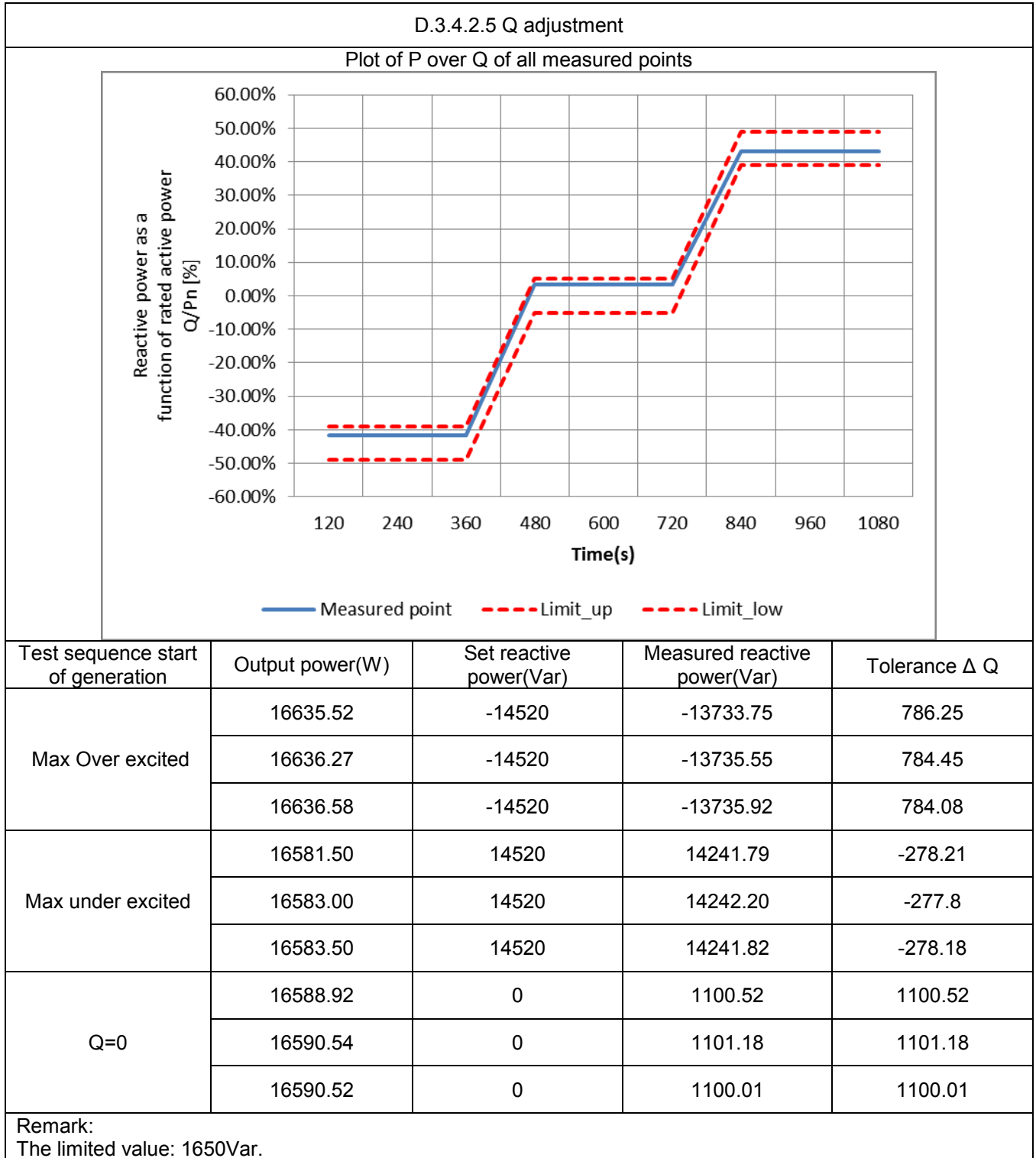

Appendix A: Tables

D.3.6.2 Connection after trip of interface protection				P
Test sequence after trip	connection	connection allowed	Primary power source	Power gradient after connection
Step a)	<47.45Hz	No	--	--
Step b)	≥47.45Hz	Yes	33936.3W	3103.00W/min
Step c)	>50.10Hz	No	--	--
Step d)	≤50.10Hz	Yes	33972.1W	3256.95W/min
Step e)	<193.2V	No	--	--
Step f)	≥195.5V	Yes	33052.5W	3252.43W/min
Step g)	>255.3V	No	--	--
Step h)	≤253V	Yes	34022.1W	3247.58W/min

Picture of the gradual power supply and reconnection: Test b) for 47.45Hz

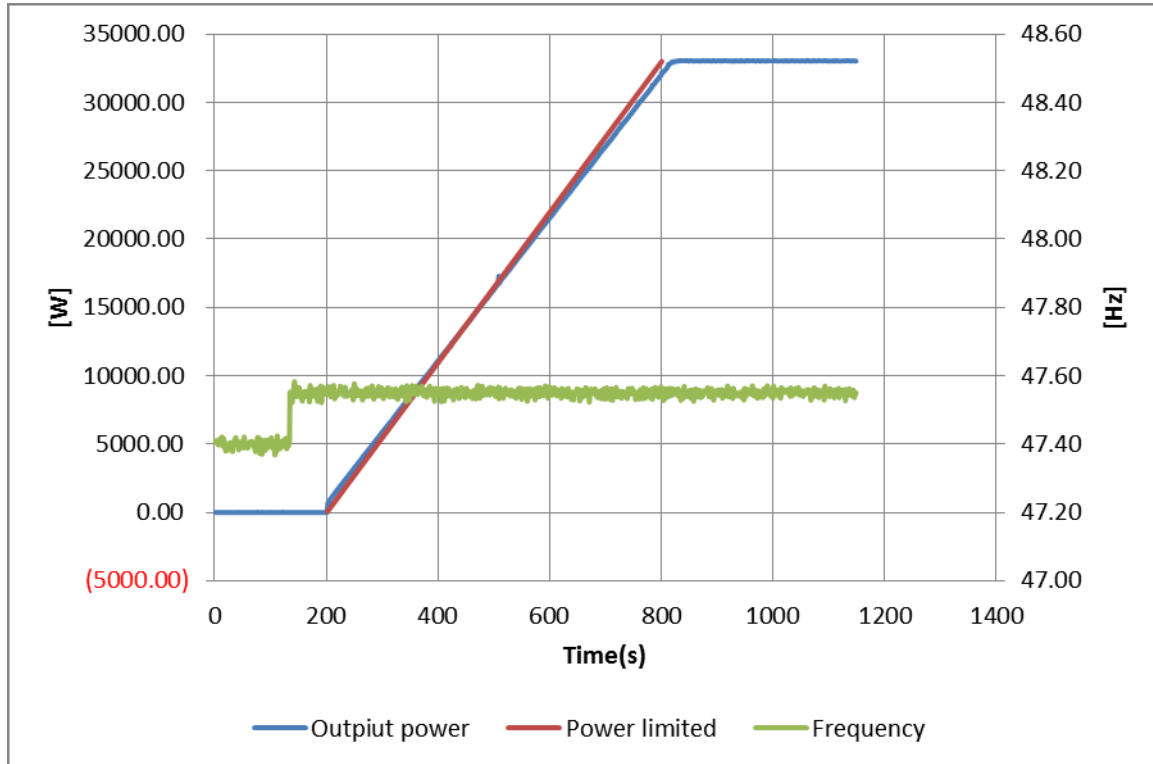

Appendix A: Tables

Picture of the gradual power supply and reconnection: Test d) for 50.10Hz

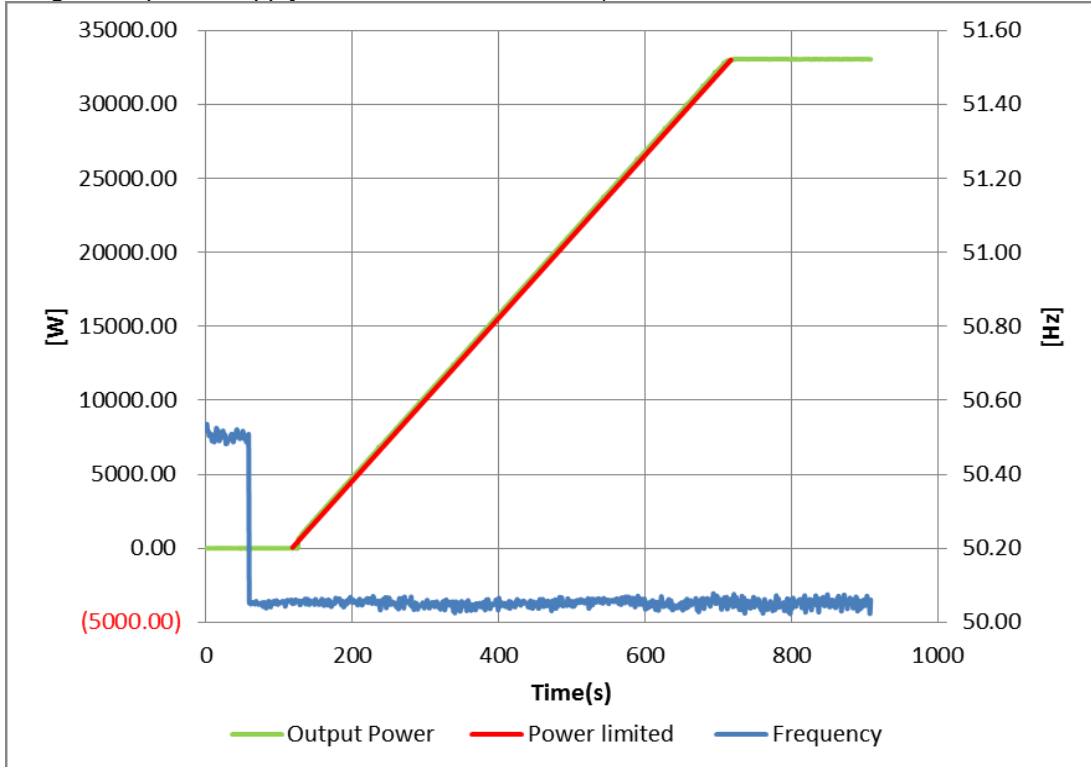

Picture of the gradual power supply and reconnection: Test f) for 195.5V

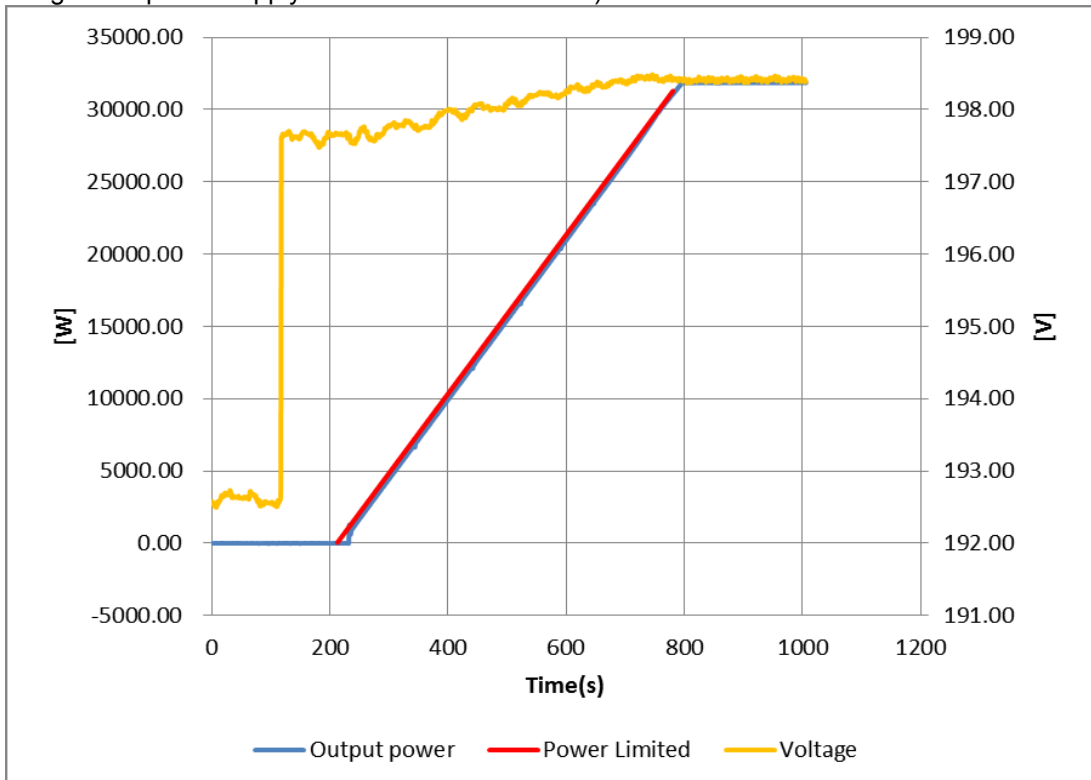

Appendix A: Tables

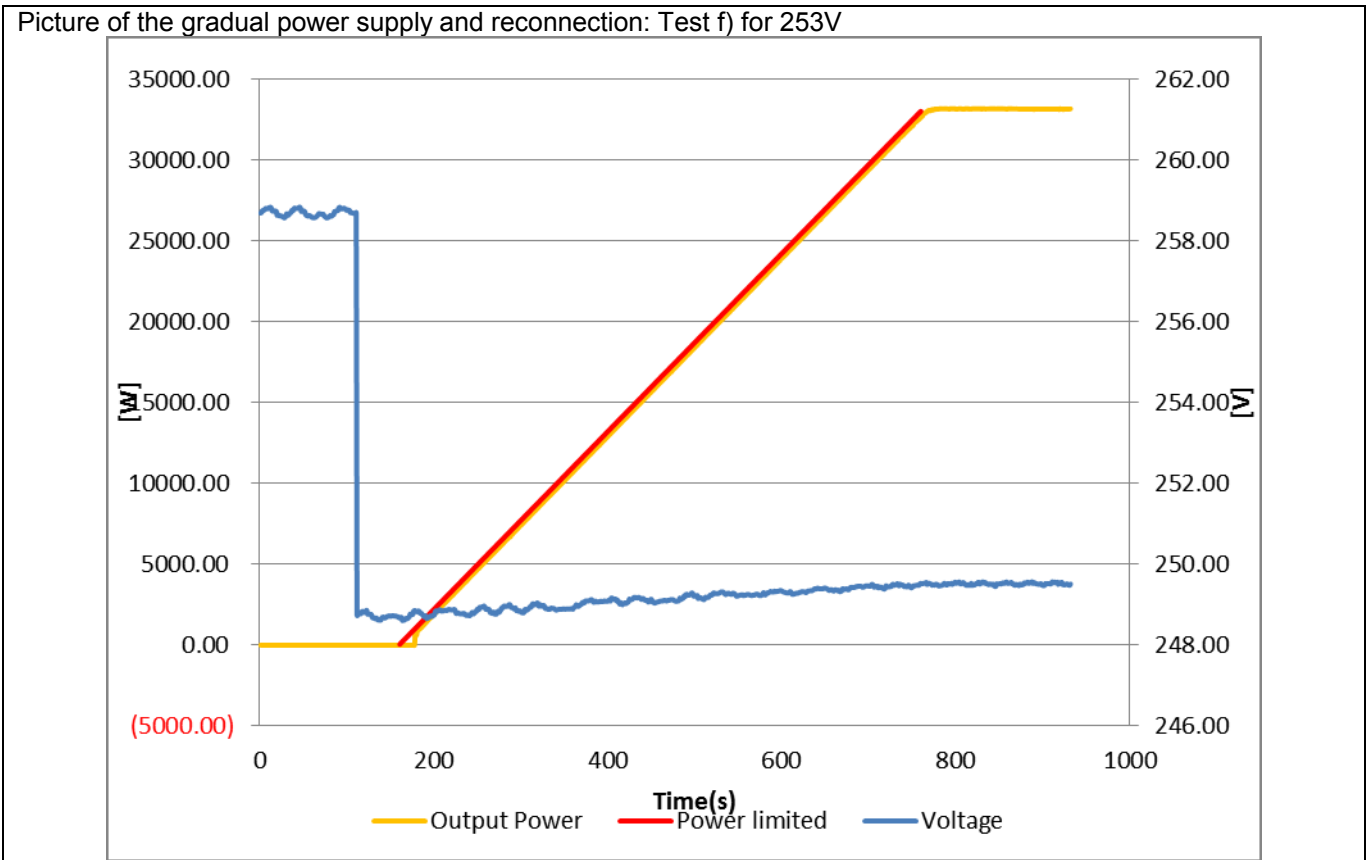

D.3.6.3 Start of generating electrical power				P
Test sequence after trip	connection	connection allowed	Primary power source	Power gradient after connection
Step a)	<47.45Hz	No	--	--
Step b)	≥47.45Hz	Yes	33936.3W	3103.00W/min
Step c)	>50.15Hz	No	--	--
Step d)	≤50.15Hz	Yes	33972.1W	3256.95W/min
Step e)	<193.2V	No	--	--
Step f)	≥193.2V	Yes	33052.5W	3252.43W/min
Step g)	>255.3V	No	--	--
Step h)	≤255.3V	Yes	34022.1W	3247.58W/min

Appendix A: Tables

D 3.8 Harmonic current emissions							
Maximum permissible harmonic current as per EN 61000-3-2 Class A							
Hamonics order n	SOFAR 20000TL-G2			SOFAR 33000TL-G2			Limit in BS EN 61000-3-2 in Amps
	Measured Value						
	L1	L2	L3	L1	L2	L3	
2	0.0524	0.0208	0.0498	0.1560	0.1291	0.1135	1.080
3	0.0702	0.0688	0.1244	0.0585	0.0600	0.0406	2.300
4	0.0435	0.0307	0.0648	0.0851	0.1137	0.0914	0.430
5	0.2457	0.1881	0.1920	0.0631	0.0758	0.0243	1.140
6	0.0370	0.0239	0.0294	0.0579	0.0373	0.0479	0.300
7	0.2480	0.2254	0.1875	0.1612	0.0917	0.1418	0.770
8	0.0083	0.0212	0.0220	0.0915	0.0567	0.0741	0.230
9	0.0314	0.0402	0.0715	0.0464	0.0281	0.0699	0.400
10	0.0220	0.0191	0.0082	0.0369	0.0191	0.0260	0.184
11	0.0916	0.1320	0.0745	0.0735	0.0663	0.0918	0.330
12	0.0207	0.0204	0.0046	0.0164	0.0164	0.0179	0.153
13	0.0679	0.0801	0.0880	0.0485	0.0302	0.0530	0.210
14	0.0205	0.0132	0.0090	0.0192	0.0160	0.0253	0.131
15	0.0103	0.0125	0.0195	0.0262	0.0226	0.0279	0.150
16	0.0172	0.0110	0.0185	0.0326	0.0191	0.0235	0.115
17	0.0737	0.0589	0.0624	0.0146	0.0262	0.0296	0.132
18	0.0043	0.0068	0.0039	0.0160	0.0146	0.0202	0.102
19	0.0563	0.0569	0.0584	0.0336	0.0310	0.0224	0.118
20	0.0049	0.0019	0.0058	0.0151	0.0159	0.0109	0.092
21	0.0042	0.0037	0.0030	0.0129	0.0119	0.0116	0.107
22	0.0054	0.0023	0.0053	0.0118	0.0122	0.0111	0.084
23	0.0343	0.0358	0.0362	0.0247	0.0274	0.0264	0.098
24	0.0038	0.0044	0.0025	0.0115	0.0118	0.0111	0.077
25	0.0335	0.0358	0.0324	0.0202	0.0172	0.0187	0.090

Appendix A: Tables

26	0.0038	0.0032	0.0027	0.0121	0.0117	0.0117	0.071
27	0.0027	0.0037	0.0059	0.0109	0.0114	0.0109	0.083
28	0.0022	0.0020	0.0031	0.0128	0.0133	0.0136	0.066
29	0.0280	0.0281	0.0280	0.0180	0.0212	0.0178	0.078
30	0.0028	0.0028	0.0016	0.0108	0.0111	0.0110	0.061
31	0.0253	0.0277	0.0286	0.0208	0.0204	0.0188	0.073
32	0.0029	0.0016	0.0033	0.0118	0.0118	0.0120	0.058
33	0.0024	0.0031	0.0027	0.0109	0.0112	0.0118	0.068
34	0.0032	0.0041	0.0020	0.0119	0.0114	0.0116	0.054
35	0.0237	0.0212	0.0211	0.0218	0.0217	0.0214	0.064
36	0.0012	0.0025	0.0018	0.0159	0.0186	0.0339	0.051
37	0.0198	0.0224	0.0233	0.0156	0.0162	0.0145	0.061
38	0.0041	0.0029	0.0015	0.0113	0.0118	0.0112	0.048
39	0.0011	0.0037	0.0046	0.0110	0.0117	0.0111	0.058
40	0.0044	0.0068	0.0066	0.0127	0.0129	0.0118	0.046

Appendix A: Tables

D 3.9 Voltage Fluctuations and Flicker					
Model: SOFAR 33000TL-G2					
Maximum permissible flicker and voltage fluctuation as per EN 61000-3-3					
Value	P _{st}	P _{lt}	d(t) – 500ms	dc	dmax
Limit	1.0	0.65	3.3%	3.3%	4%
Test value	0.14	0.14	0	0.03	0.20
Test: SOFAR 33000TL-G2					
	No.	dc[%]	dmax[%]	d(t)[ms]	P _{st}
	1	0.02	0.17	0.00	0.13
	2	0.01	0.18	0.00	0.13
	3	0.01	0.19	0.00	0.14
	4	0.03	0.18	0.00	0.13
	5	0.02	0.19	0.00	0.13
	6	0.00	0.12	0.00	0.13
	7	0.01	0.20	0.00	0.16
	8	0.02	0.18	0.00	0.14
	9	0.02	0.20	0.00	0.16
	10	0.03	0.20	0.00	0.16
	11	0.02	0.20	0.00	0.14
	12	0.02	0.18	0.00	0.14
					P _{lt}
					0.14
Model: SOFAR 33000TL-G2					
Maximum permissible flicker and voltage fluctuation as per EN 61000-3-3					
Value	P _{st}	P _{lt}	d(t) – 500ms	dc	dmax
Limit	1.0	0.65	3.3%	3.3%	4%
Test value	0.11	0.11	0	0.06	0.11
Test: SOFAR 20000TL-G2					
	No.	dc[%]	dmax[%]	d(t)[ms]	P _{st}
	1	0.06	0.11	0.00	0.11
	2	0.00	0.00	0.00	0.11
	3	0.00	0.00	0.00	0.11
	4	0.00	0.00	0.00	0.11
	5	0.01	0.10	0.00	0.11
	6	0.00	0.00	0.00	0.11
	7	0.00	0.00	0.00	0.11
	8	0.00	0.00	0.00	0.11
	9	0.00	0.00	0.00	0.11
	10	0.00	0.00	0.00	0.11
	11	0.00	0.00	0.00	0.11
	12	0.00	0.00	0.00	0.11
					P _{lt}
					0.11

Appendix A: Tables

D.3.10 DC injection					
		Power level			
		20%	50%	75%	100%
DC current(A)	R	0.0341	0.1015	0.1181	0.0753
	S	0.0280	0.0300	0.0270	0.1001
	T	0.0076	0.0511	0.0807	0.0052
% of nominal current	R	0.0710	0.2115	0.2460	0.1569
	S	0.0583	0.0625	0.0563	0.2085
	T	0.0158	0.1065	0.1681	0.0108

Appendix B: Photos

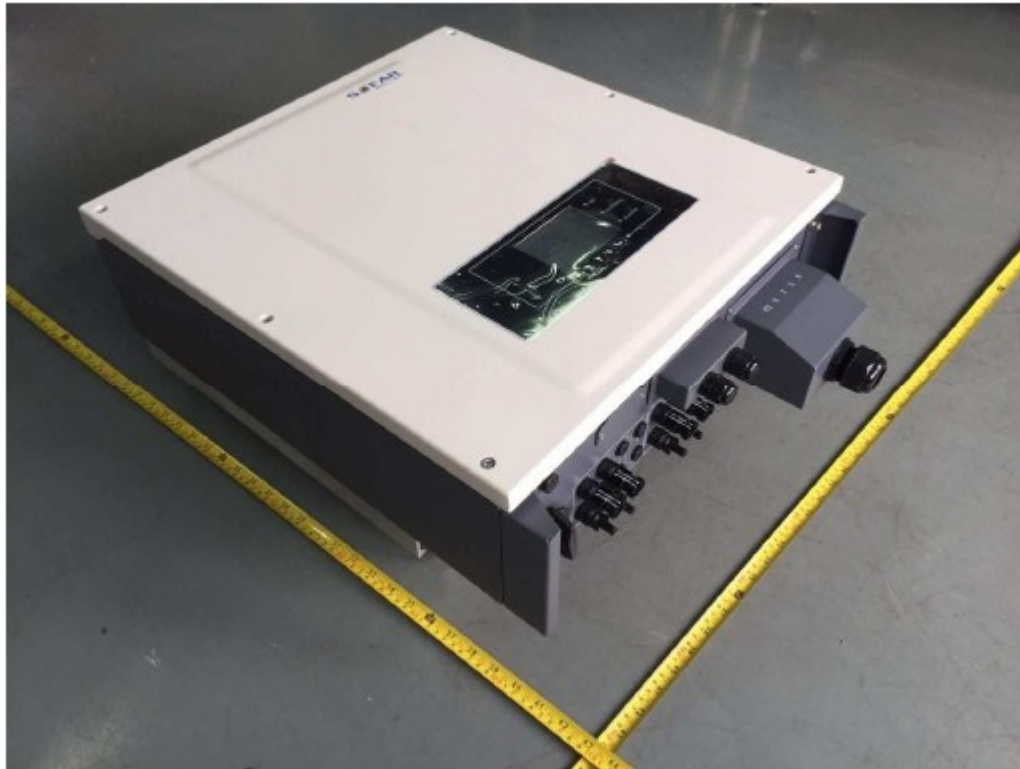

Enclosure front view: SOFAR 20000TL-G2

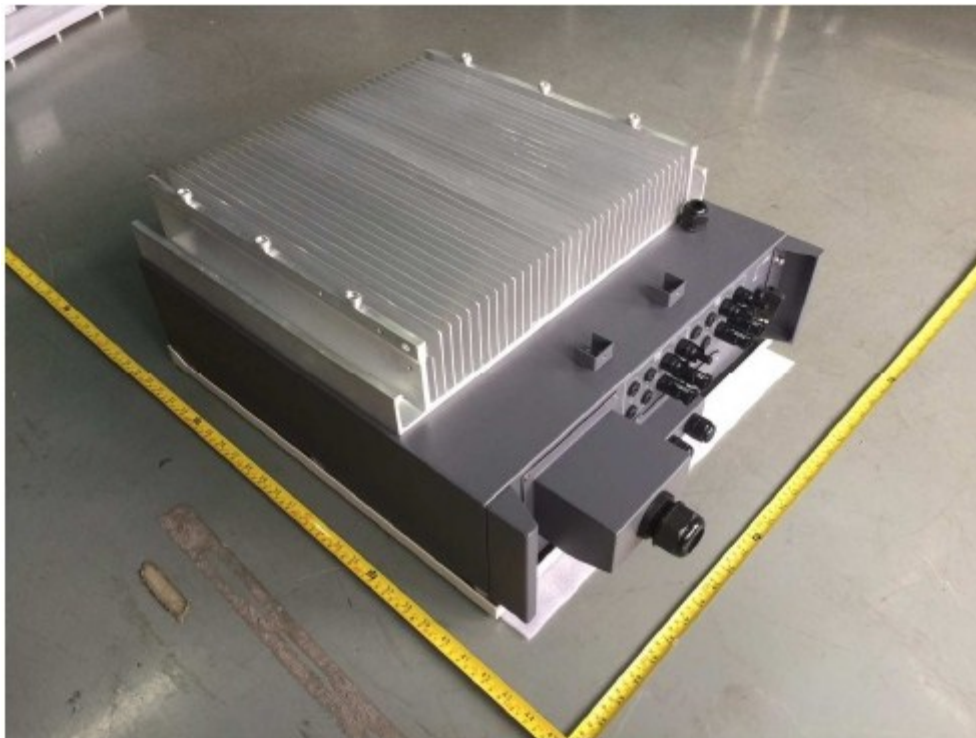

Enclosure rear view: SOFAR 20000TL-G2

Appendix B: Photos



Enclosure front view: SOFAR 25000TL-G2

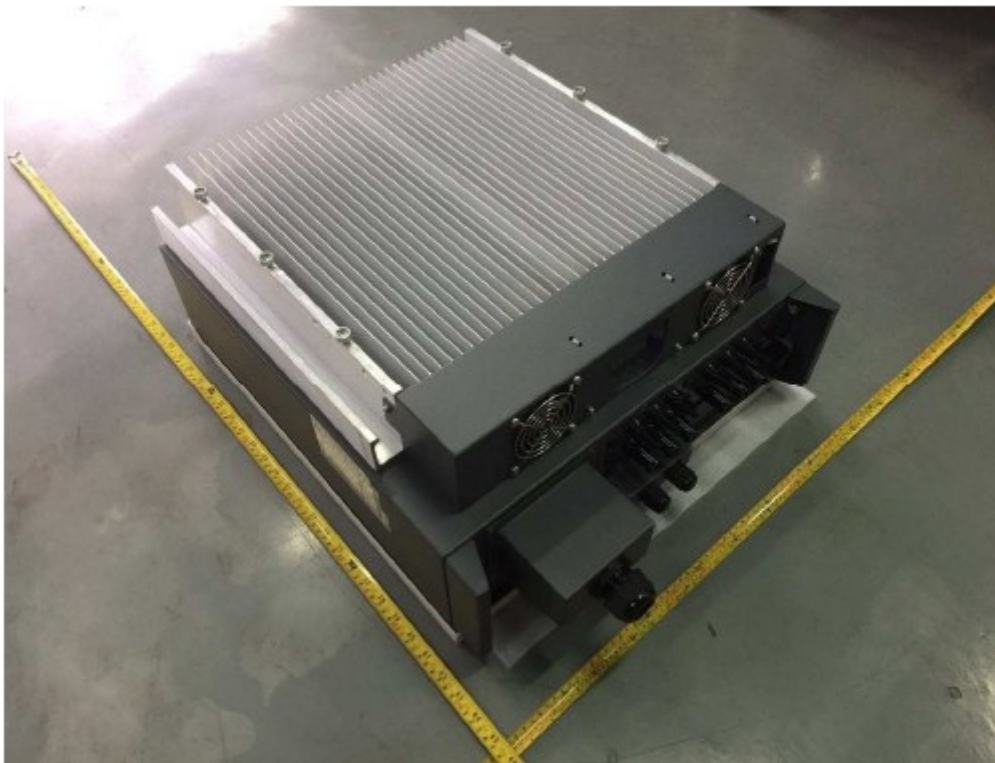

Enclosure rear view: SOFAR 25000TL-G2

Appendix B: Photos



Enclosure front view: SOFAR 30000TL-G2, SOFAR 33000TL-G2



Enclosure rear view: SOFAR 30000TL-G2, SOFAR 33000TL-G2

Appendix B: Photos



Internal view: SOFAR 20000TL-G2



Internal view: SOFAR 25000TL-G2

Appendix B: Photos



Internal view: SOFAR 30000TL-G2, SOFAR 33000TL-G2

(End of Report)